

SIZE : 1-1/2x1-1/2x9B TYPE : 382 IMPELLER : Enclosed R. P. M. : 1750

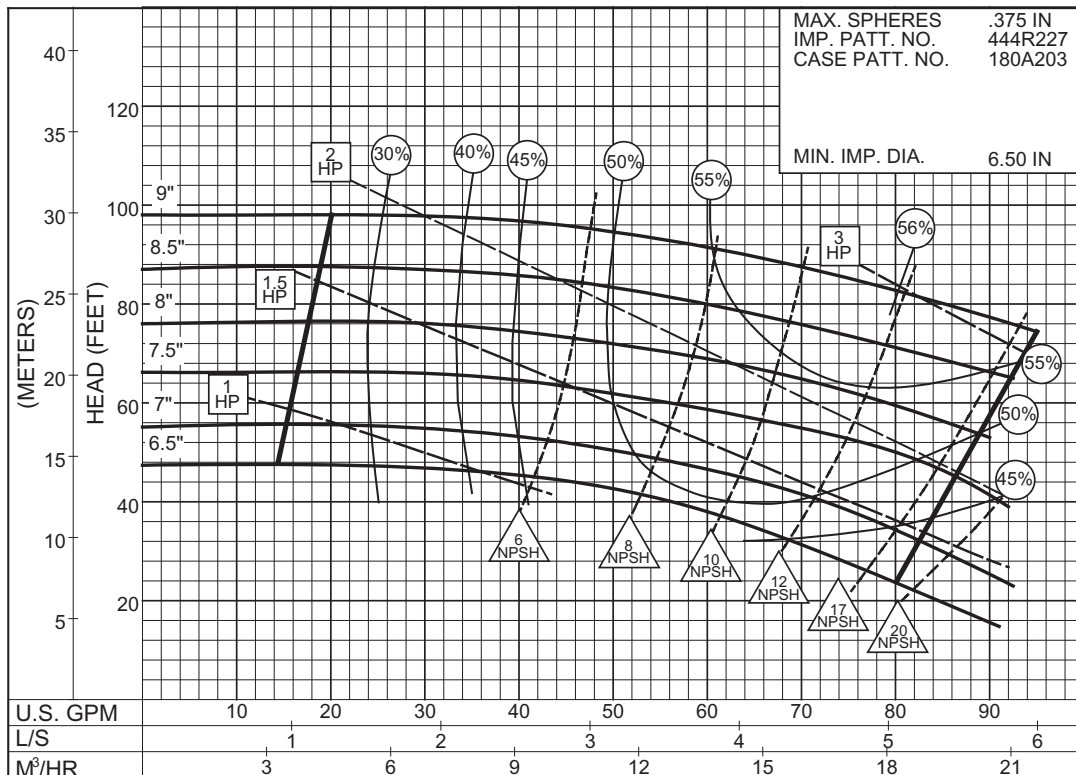

**1750
R.P.M**

3PC-116274A

SIZE : 2x2x7 TYPE : 382 IMPELLER : Enclosed R. P. M. : 3500

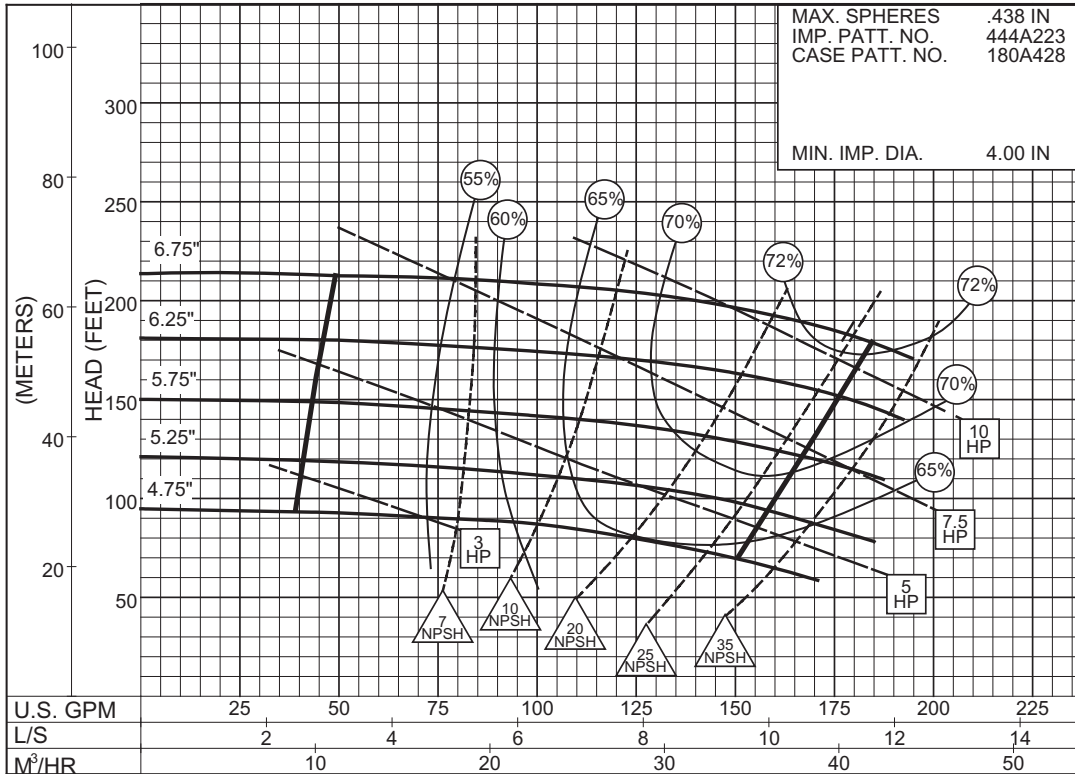

PC-177171

3500
R.P.M

SIZE : 2x2x7 TYPE : 382 IMPELLER : Enclosed R. P. M. : 1750

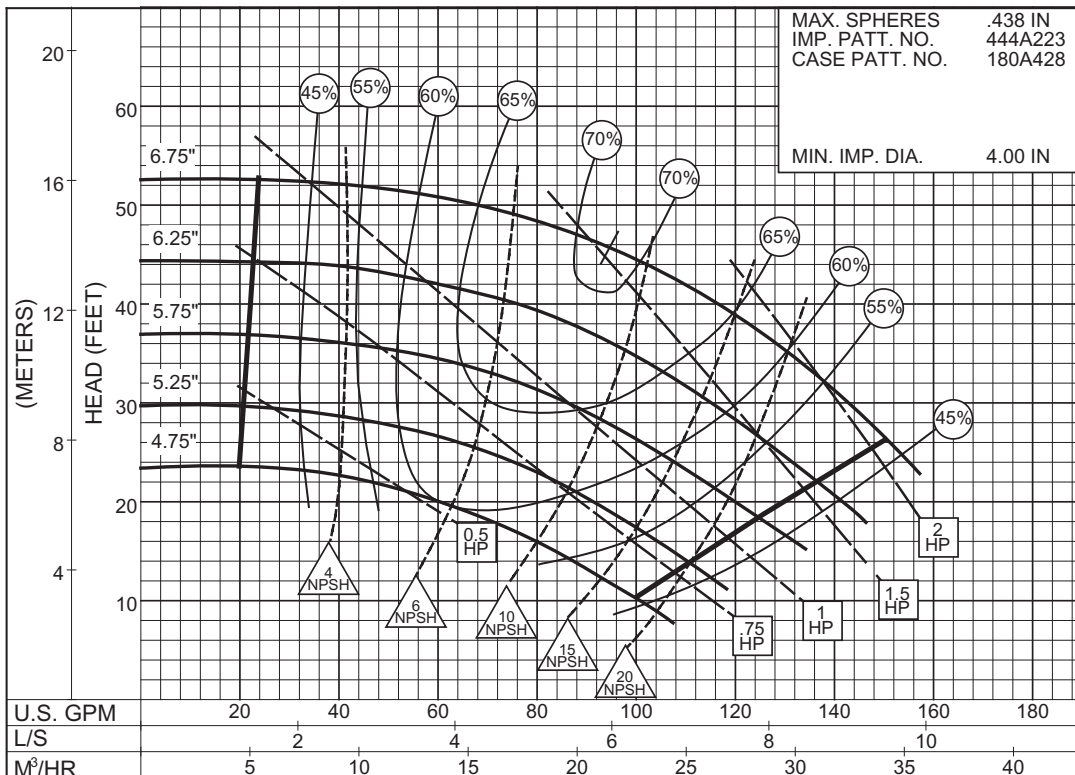

PC-177172

1750
R.P.M

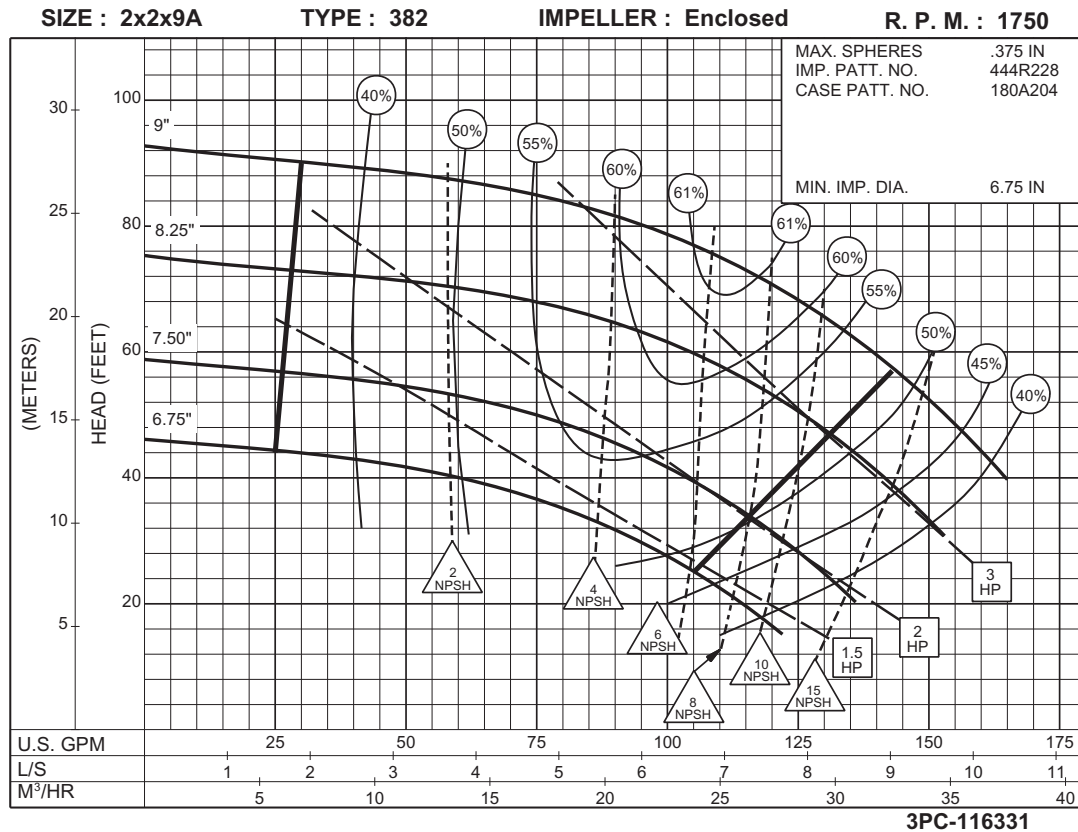

1750 R.P.M

SIZE : 2x2x9B TYPE : 382 IMPELLER : Enclosed R. P. M. : 1750

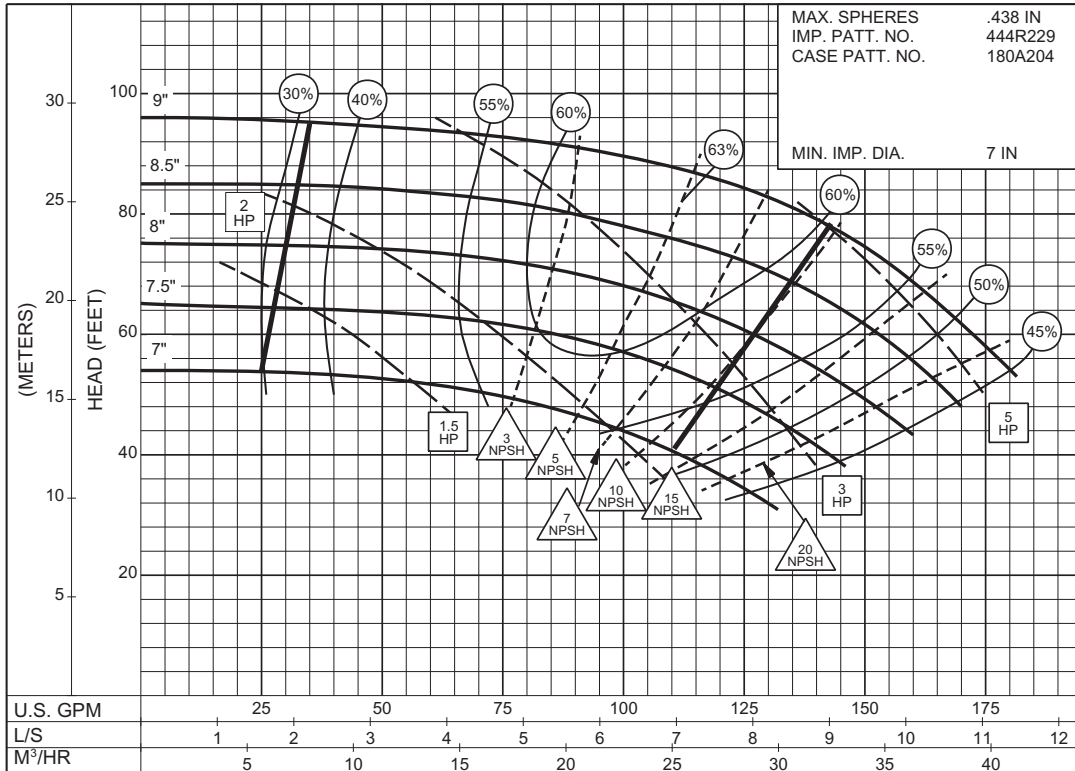

1750
R.P.M

3PC-116277

SIZE : 2x2x9C TYPE : 382 IMPELLER : Enclosed R. P. M. : 3500

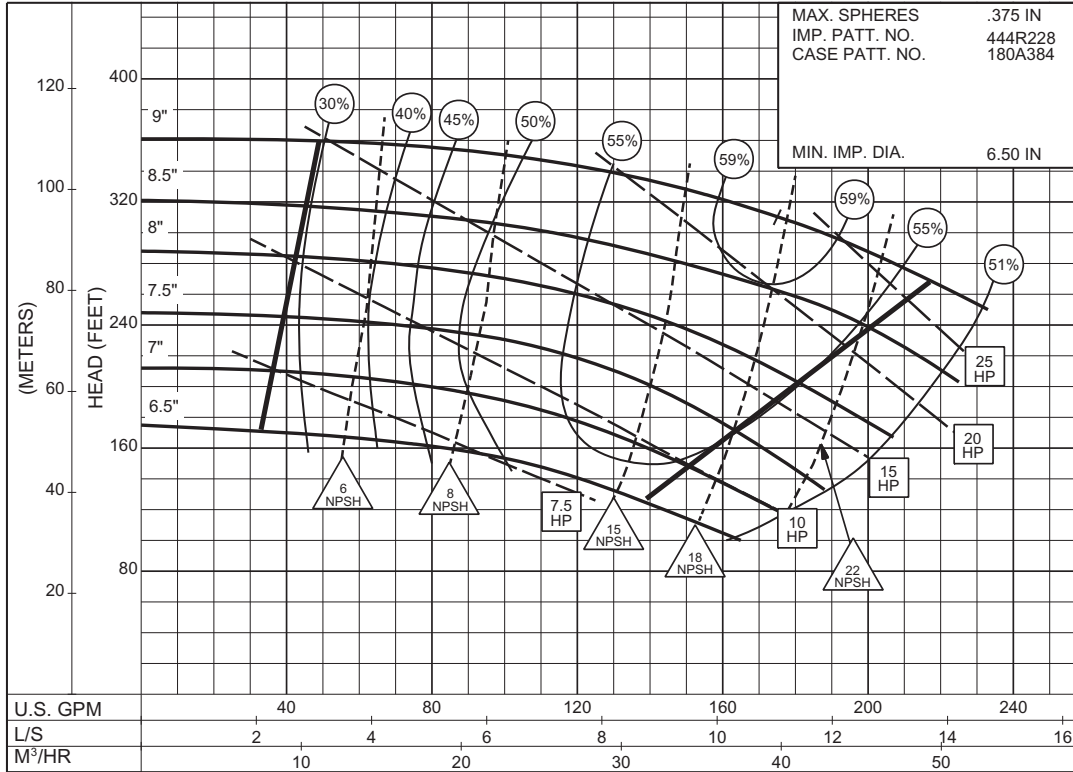

3PC-159191

3500
R.P.M

SIZE : 2x2x9C TYPE : 382 IMPELLER : Enclosed R. P. M. : 1750

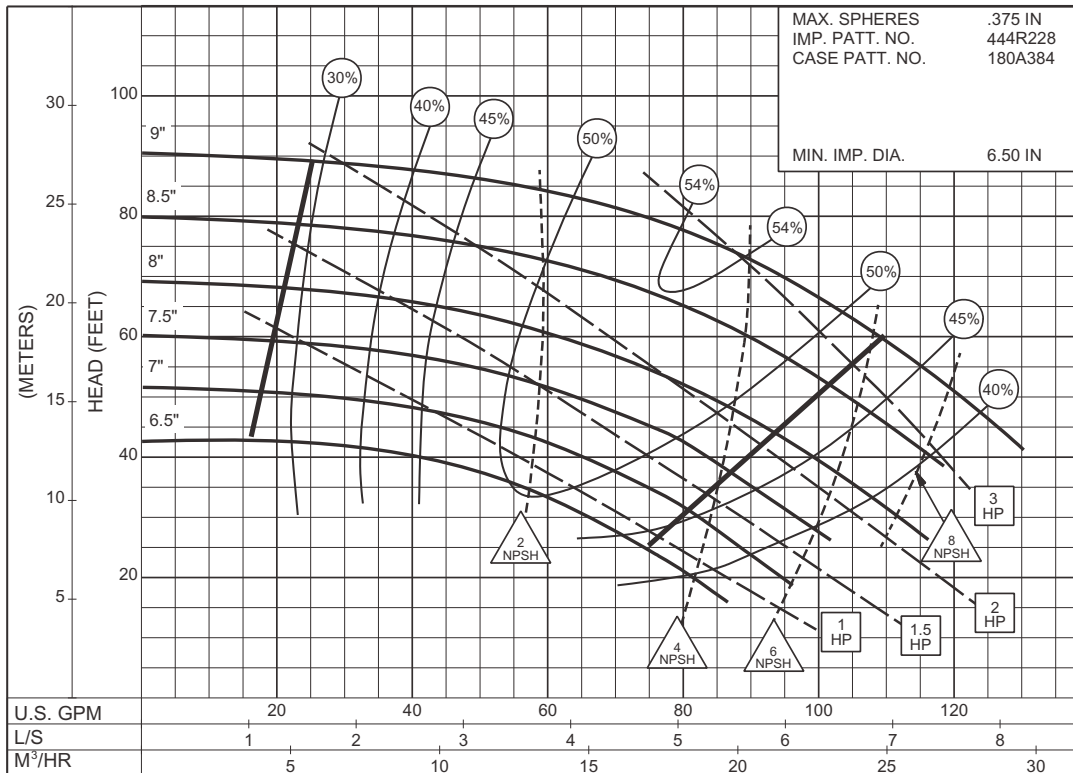

3PC-116279

1750
R.P.M

SIZE : 2x2x12 TYPE : 382 IMPELLER : Enclosed R. P. M. : 1750

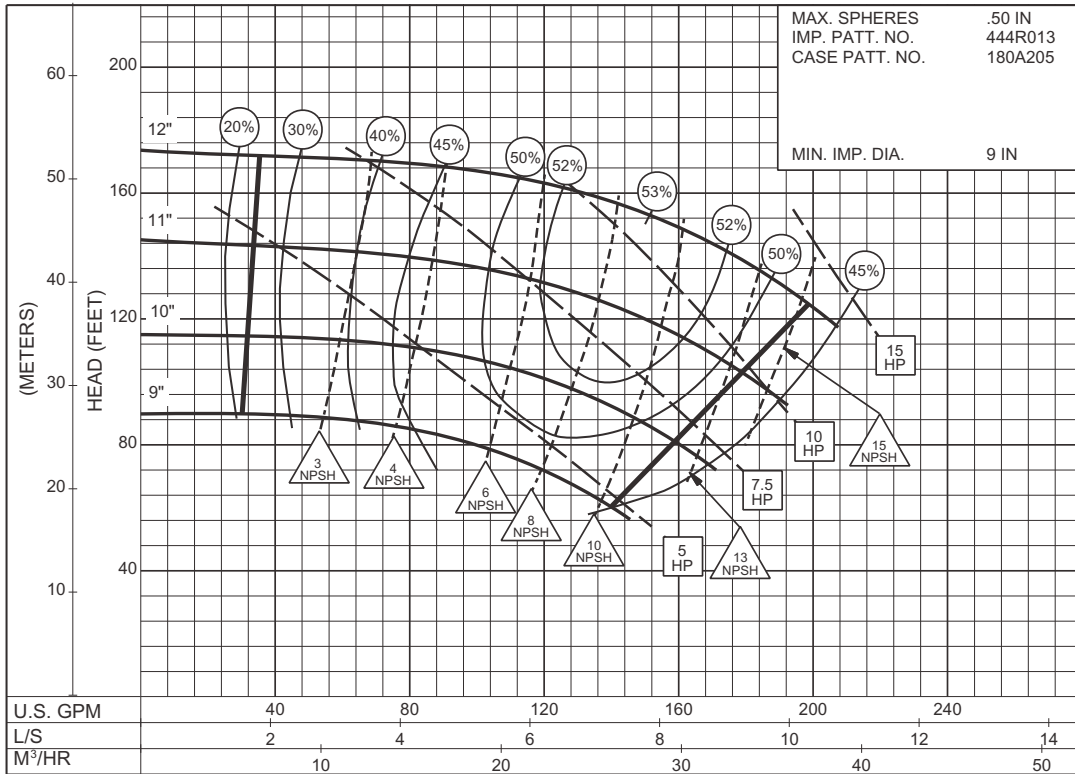

3PC-116280A

**1750
R.P.M**

SIZE : 2x2x12 TYPE : 382 IMPELLER : Enclosed R. P. M. : 1150

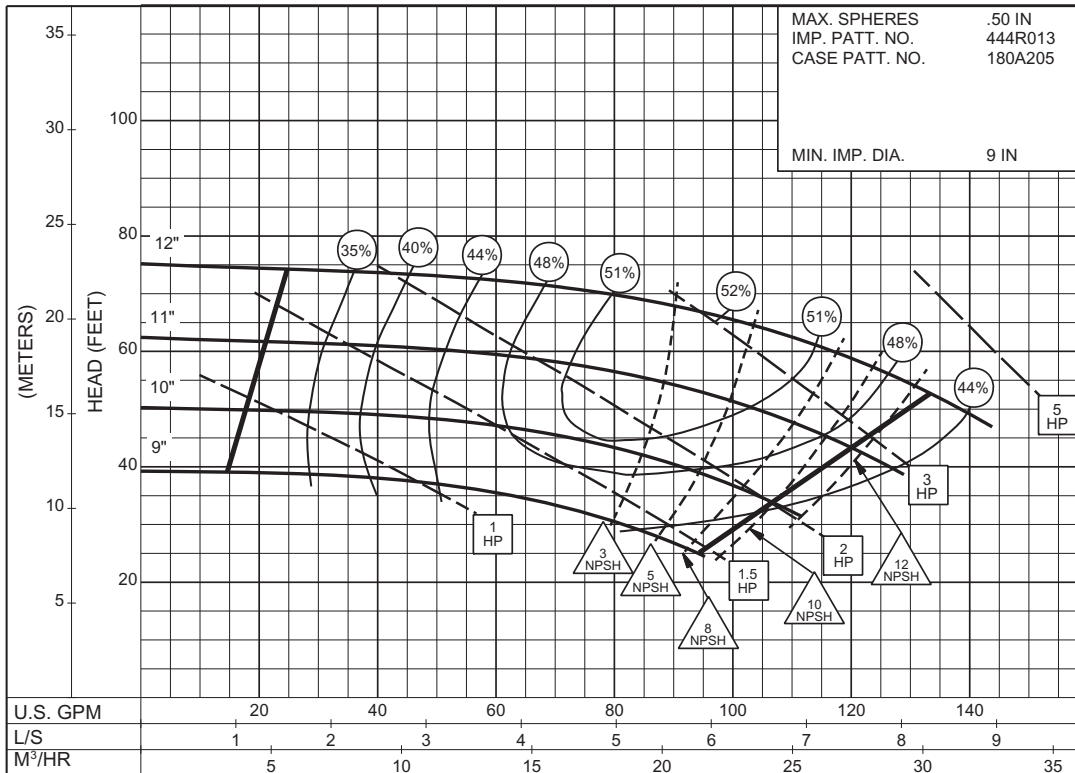

3PC-116281A

**1150
R.P.M**

SIZE : 2-1/2x2-1/2x7 TYPE : 382 IMPELLER : Enclosed R. P. M. : 3500

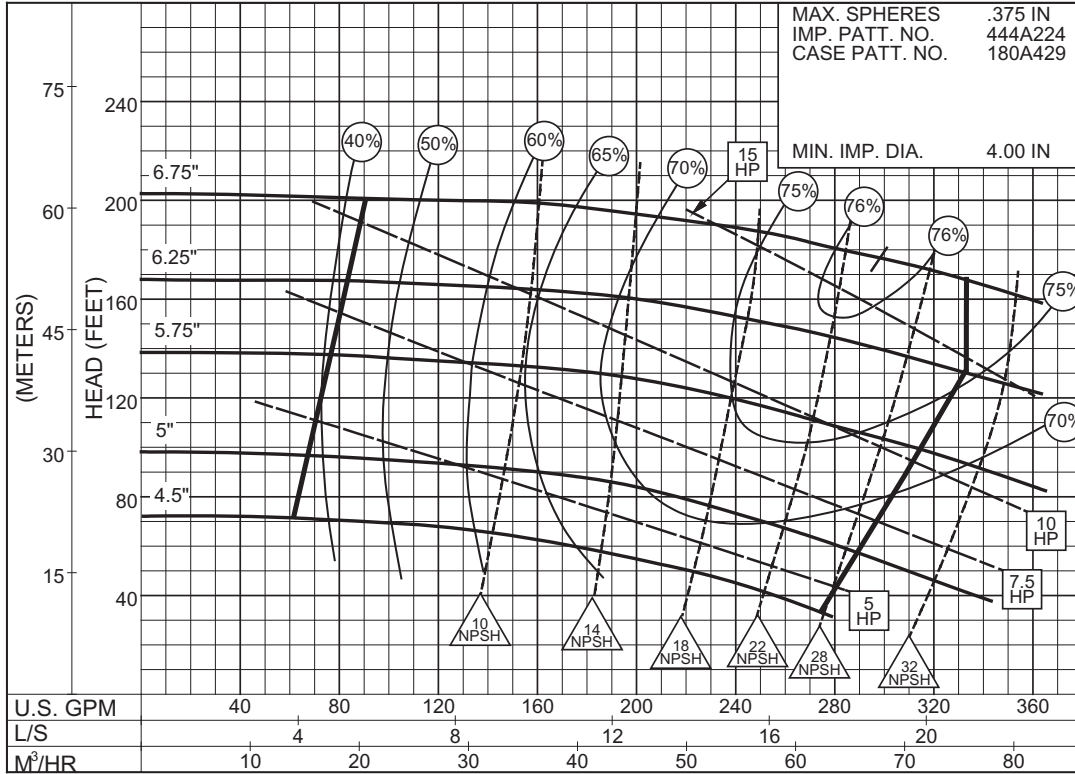

PC-177175



SIZE : 2-1/2x2-1/2x7 TYPE : 382 IMPELLER : Enclosed R. P. M. : 1750

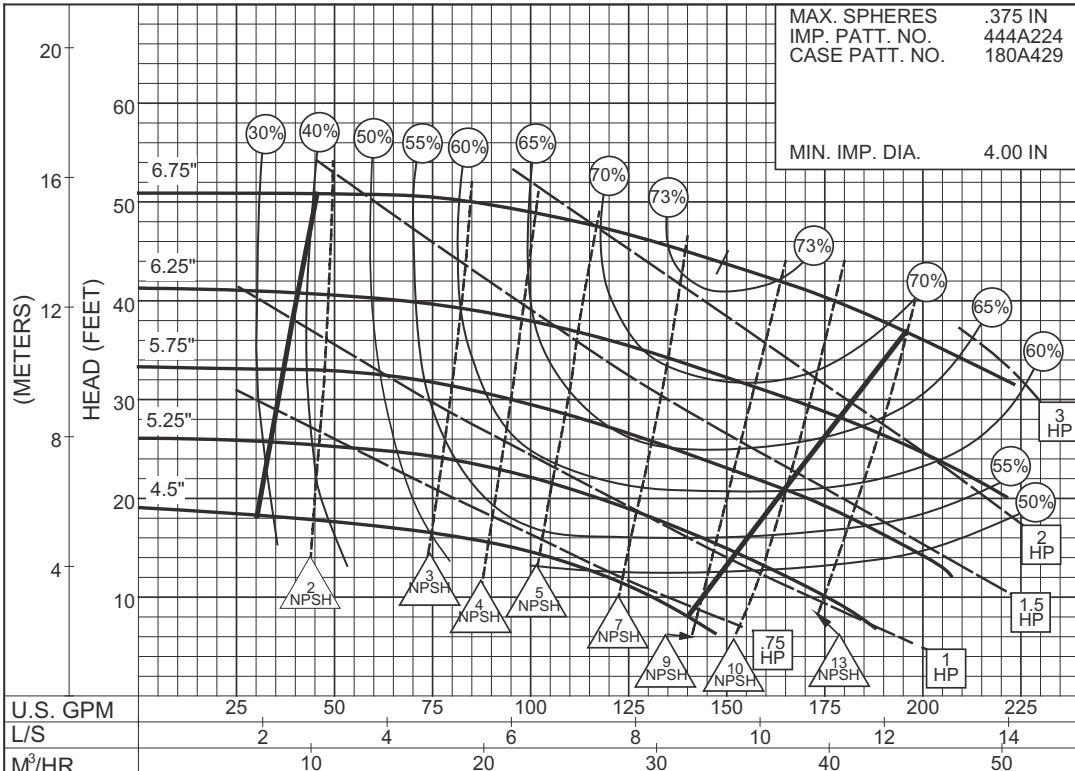

3PC-177176



SIZE : 2-1/2x2-1/2x9 TYPE : 382 IMPELLER : Enclosed R. P. M. : 3500

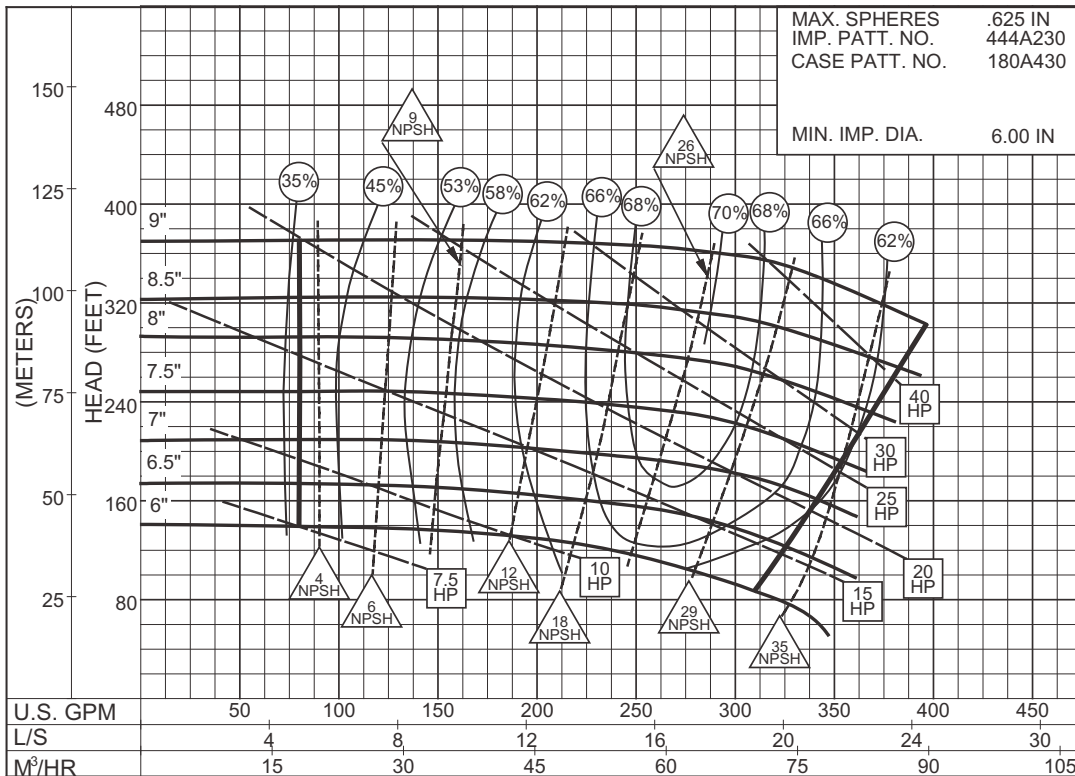

3PC-177179

3500
R.P.M

SIZE : 2-1/2x2-1/2x9 TYPE : 382 IMPELLER : Enclosed R. P. M. : 1750

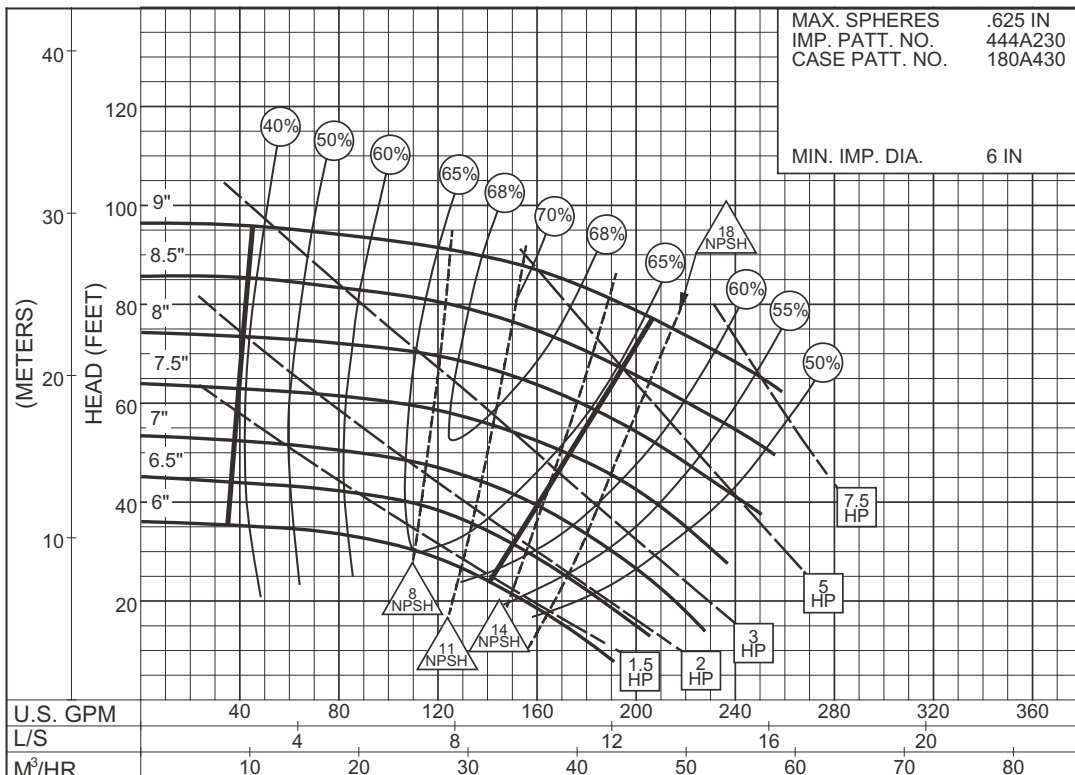

3PC-177180

1750
R.P.M

SIZE : 3x3x7A TYPE : 382 IMPELLER : Enclosed R. P. M. : 3500

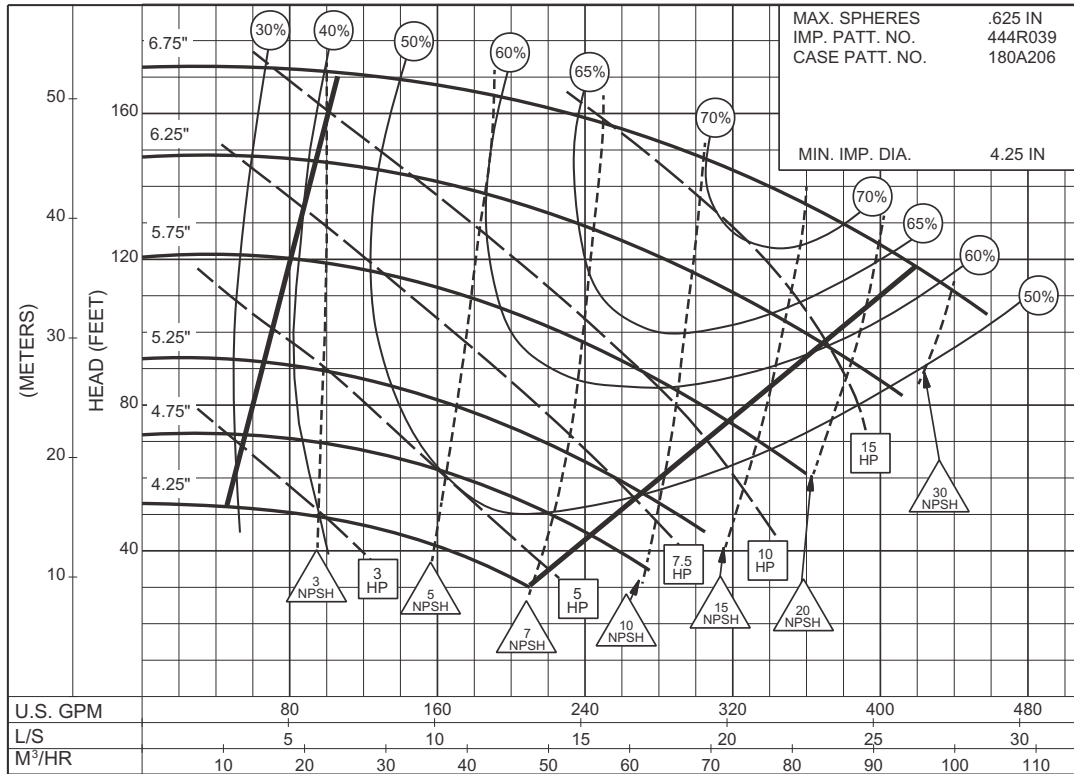

3PC-116290

3500 R.P.M

SIZE : 3x3x7A TYPE : 382 IMPELLER : Enclosed R. P. M. : 1750

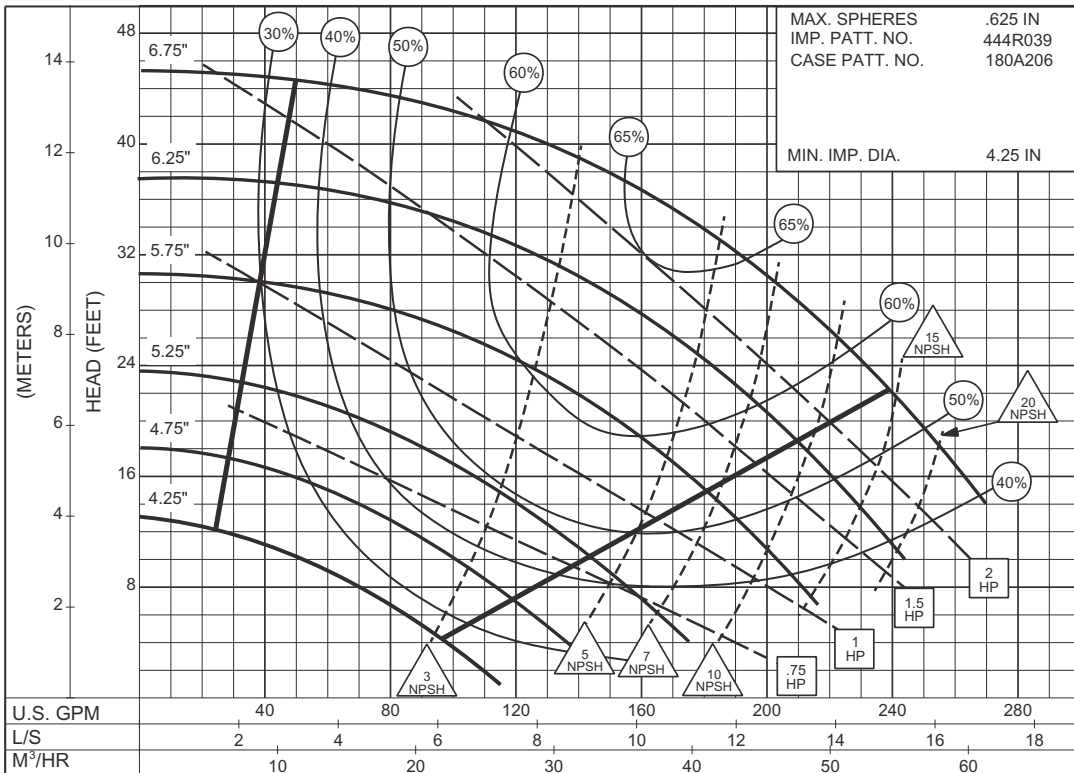

3PC-116291

1750 R.P.M

SIZE : 3x3x7B TYPE : 382 IMPELLER : Enclosed R. P. M. : 3500

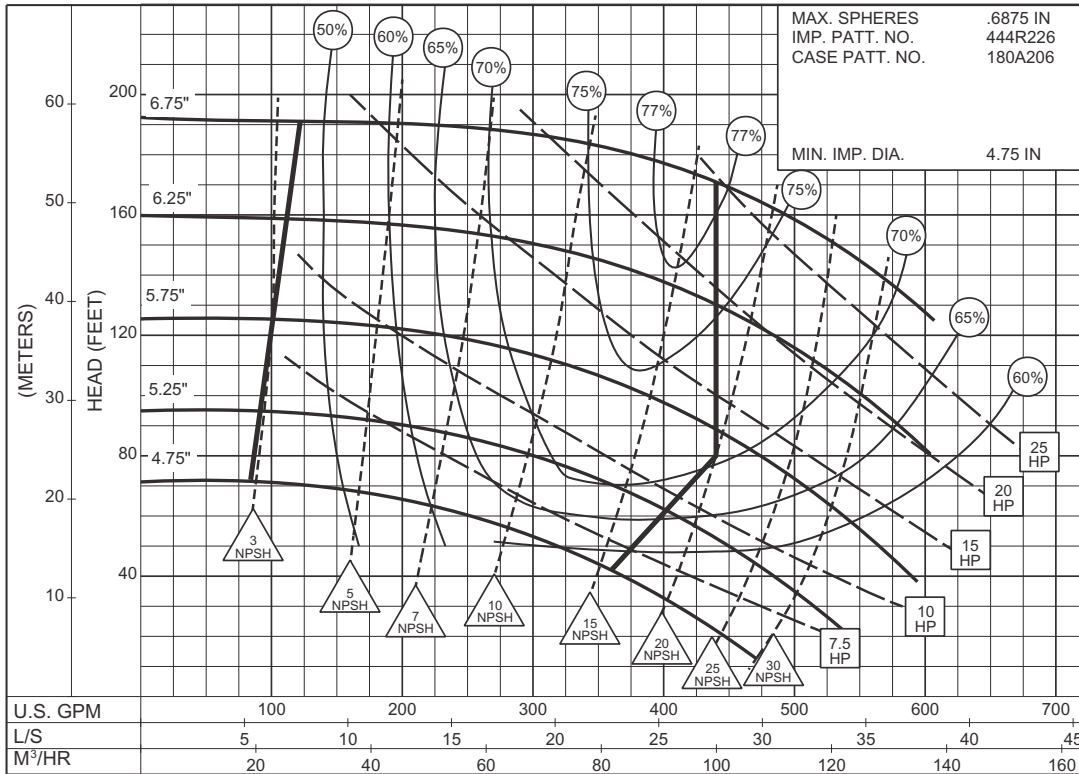

3PC-116292

3500
R.P.M

SIZE : 3x3x7B TYPE : 382 IMPELLER : Enclosed R. P. M. : 1750

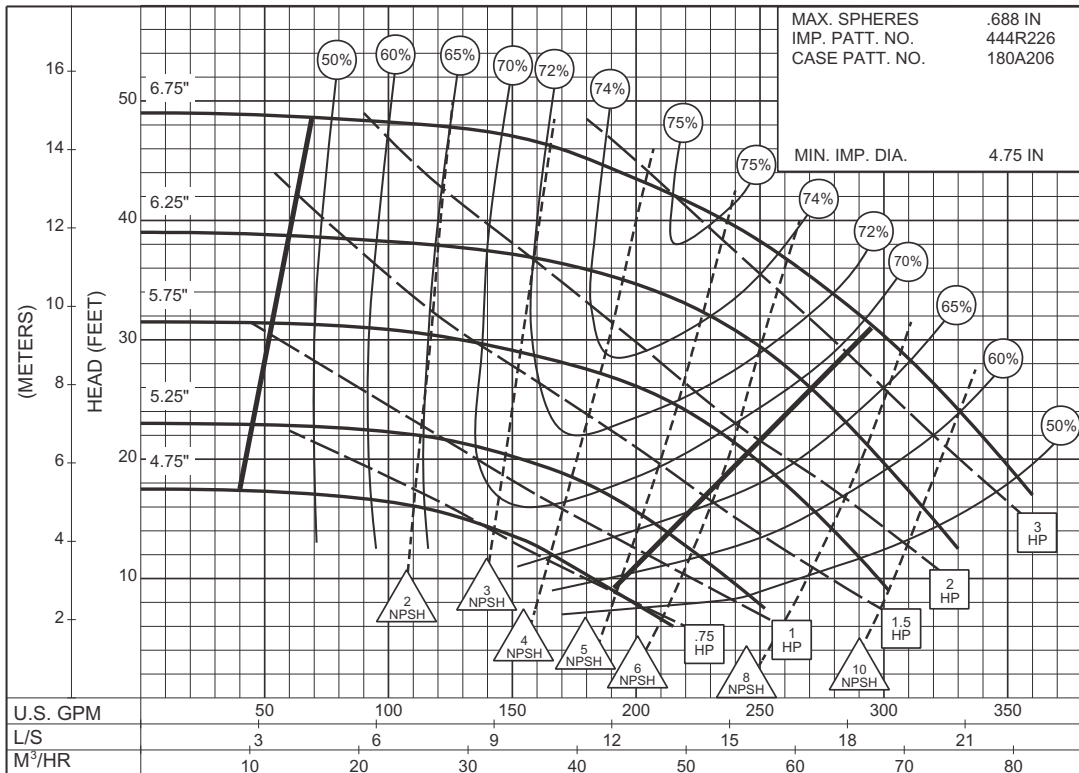

3PC-116293

1750
R.P.M

SIZE : 3x3x9A TYPE : 382 IMPELLER : Enclosed R. P. M. : 3500

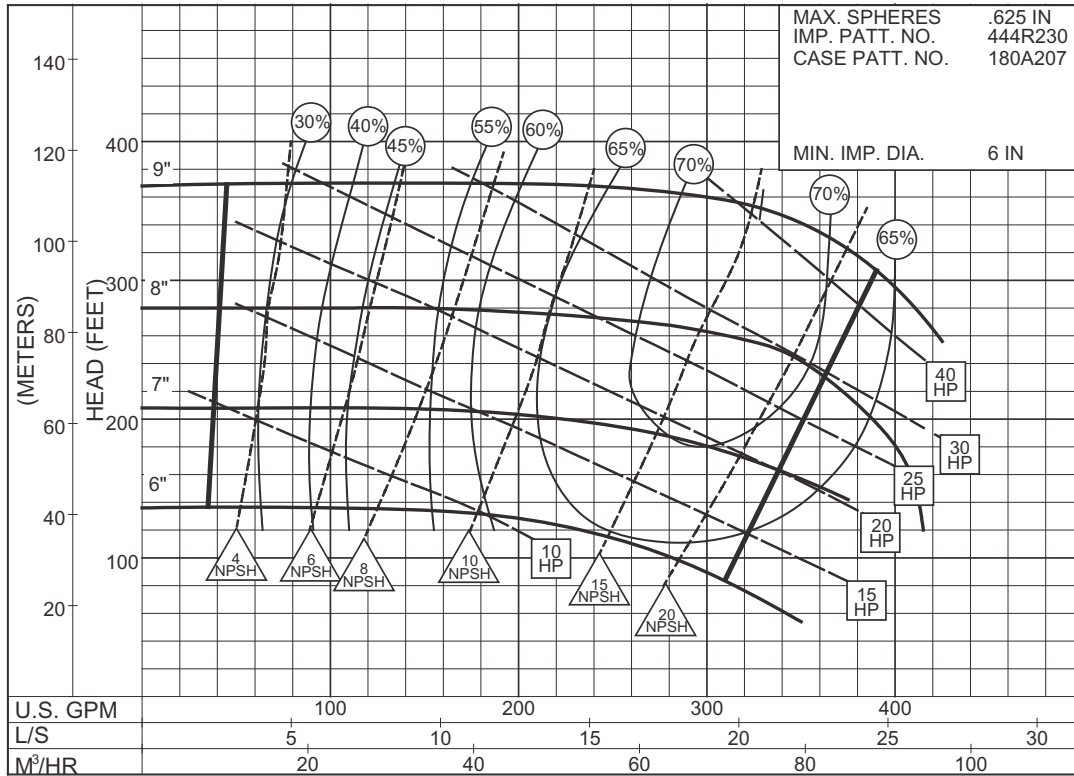

3500 R.P.M

3PC-159192

SIZE : 3x3x9A TYPE : 382 IMPELLER : Enclosed R. P. M. : 1750

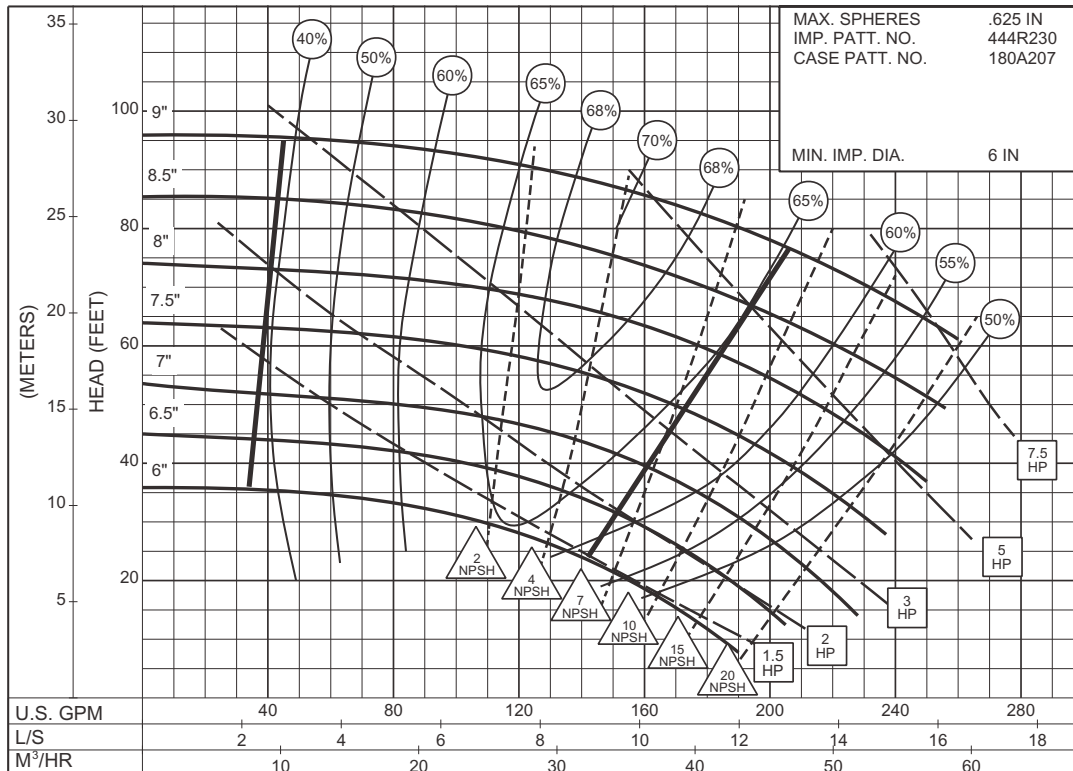

1750 R.P.M

3PC-116287

SIZE : 3x3x9B TYPE : 382 IMPELLER : Enclosed R. P. M. : 3500

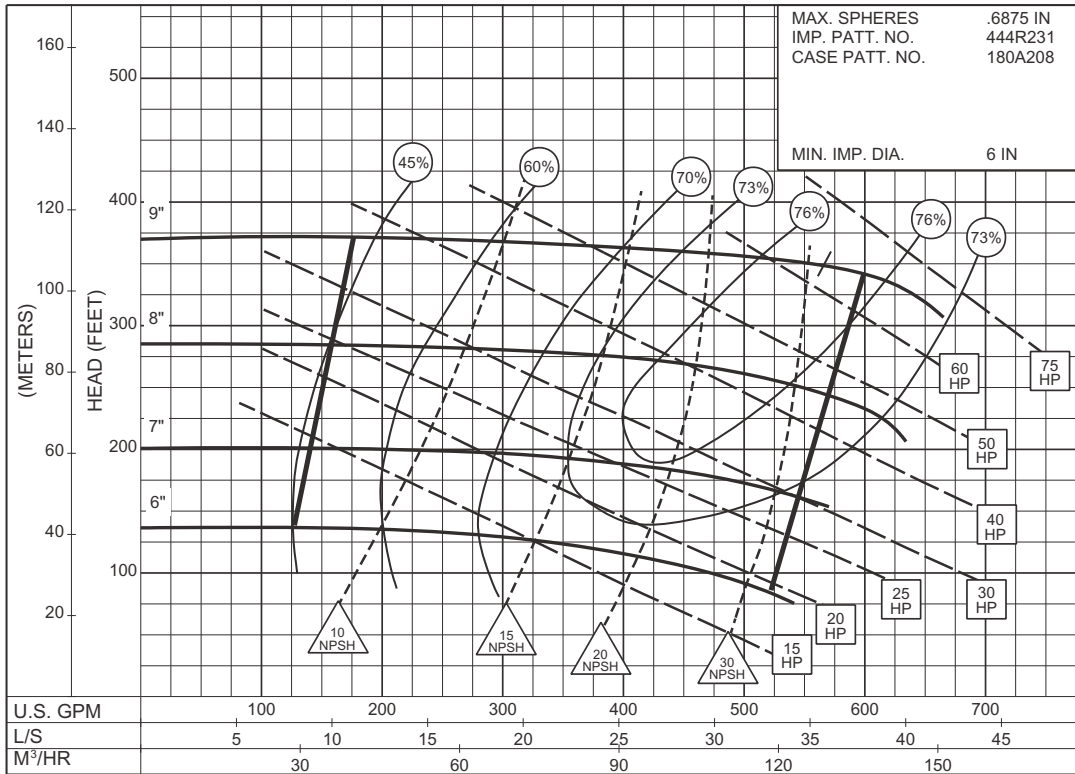

3PC-140728

**3500
R.P.M**

SIZE : 3x3x9B TYPE : 382 IMPELLER : Enclosed R. P. M. : 1750

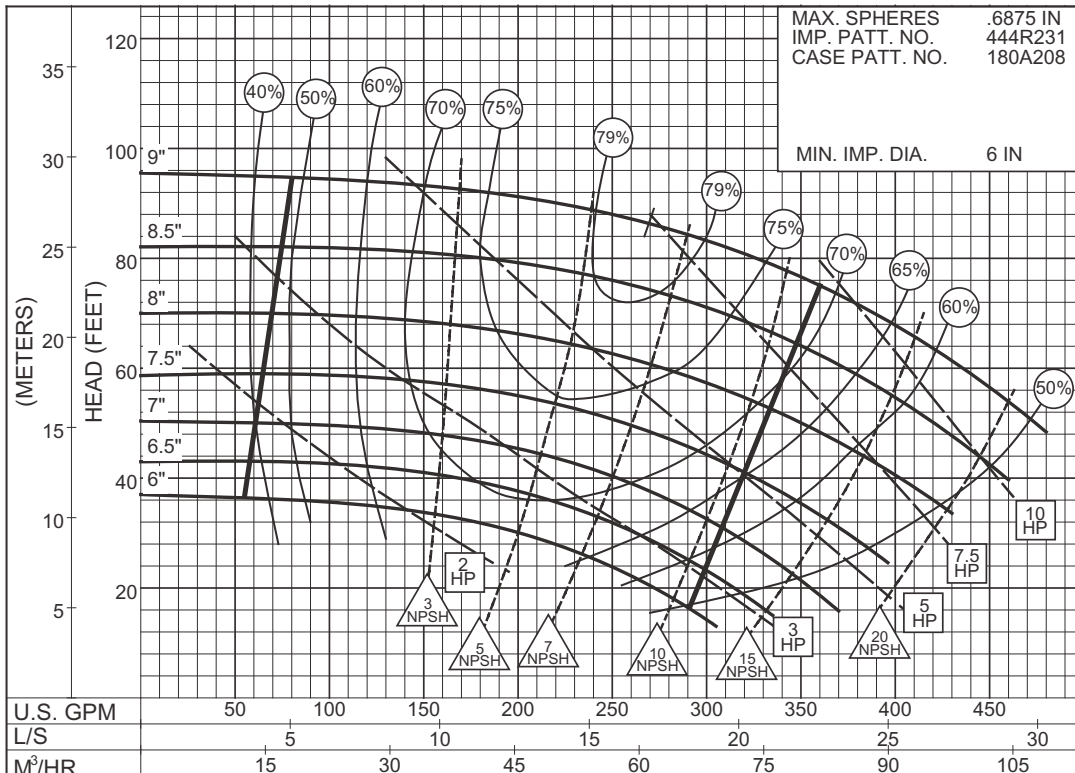

3PC-116295

**1750
R.P.M**

3 x 4 x 9 SERIES 380

ENCLOSED IMPELLER

SIZE : 3X4X9 TYPE : 382 IMPELLER : Enclosed R. P. M. : 3500

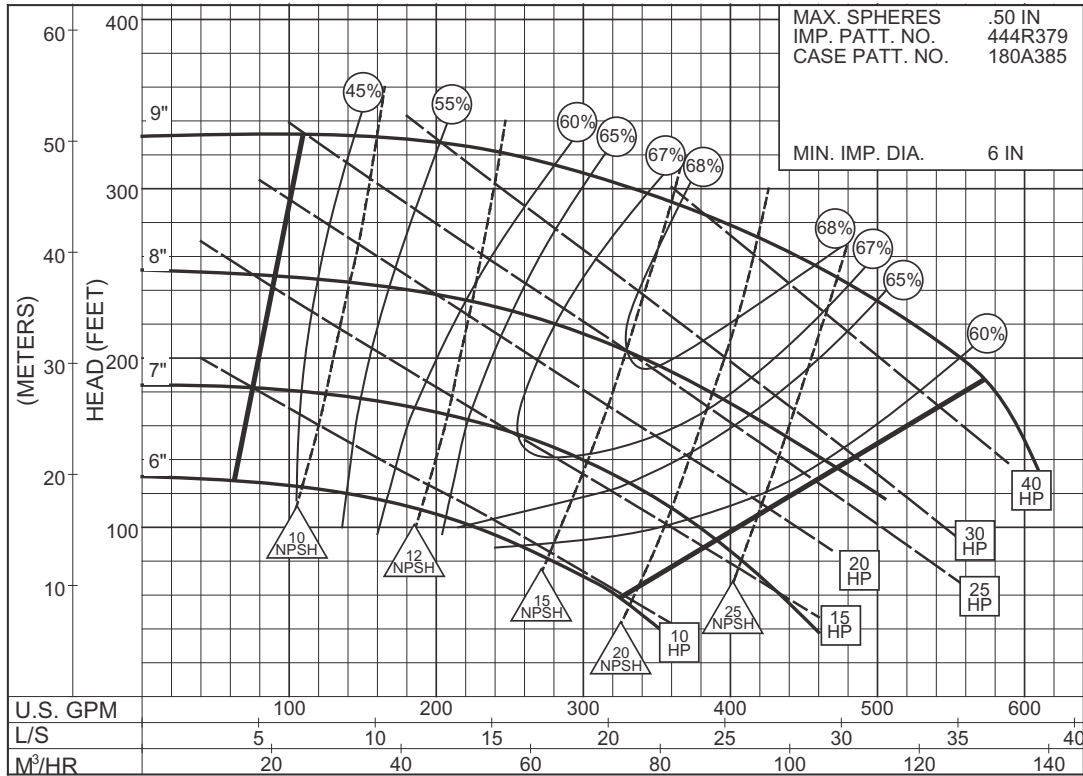

3PC-159193

3500
R.P.M

SIZE : 3x4x9 TYPE : 382 IMPELLER : Enclosed R. P. M. : 1750

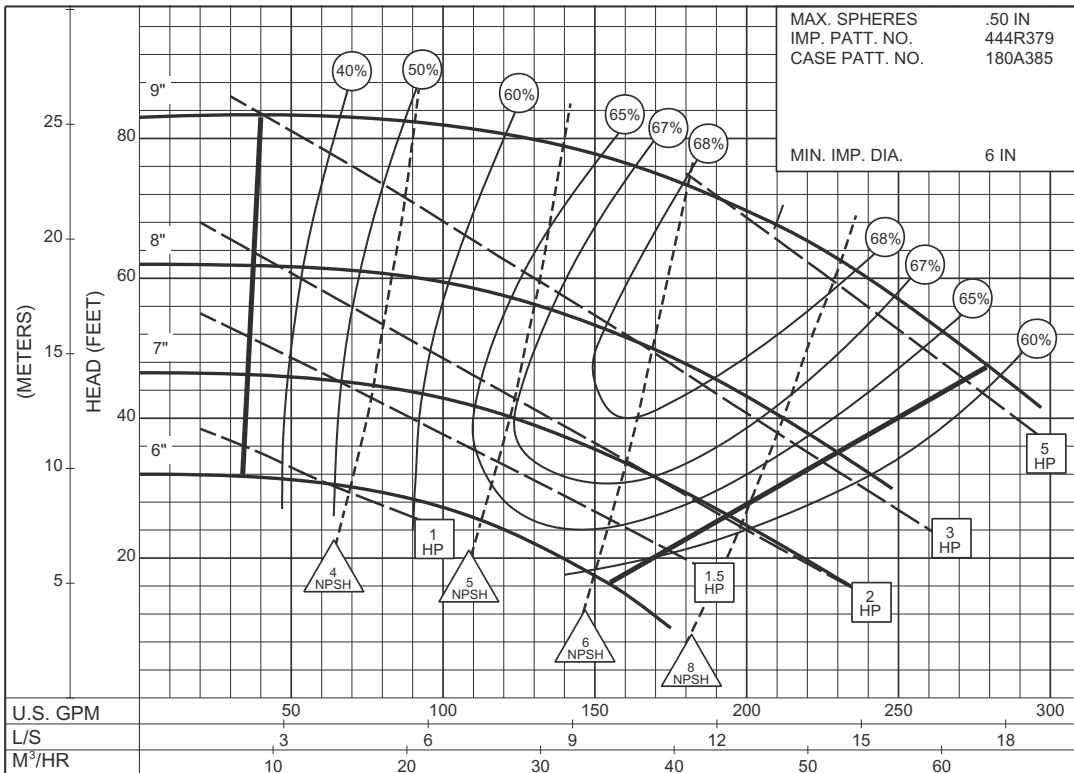

3PC-159194

1750
R.P.M

SIZE : 3x3x12 TYPE : 382 IMPELLER : Enclosed R. P. M. : 1750

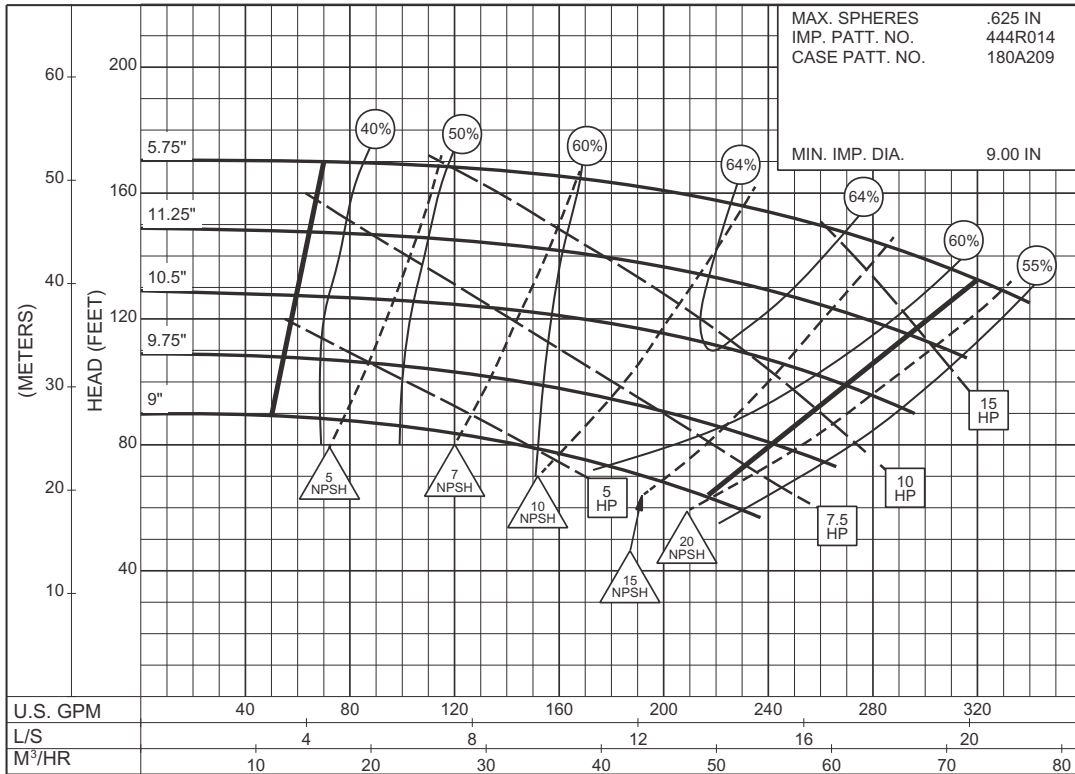

3PC-116288

**1750
R.P.M**

SIZE : 3x3x12 TYPE : 382 IMPELLER : Enclosed R. P. M. : 1150

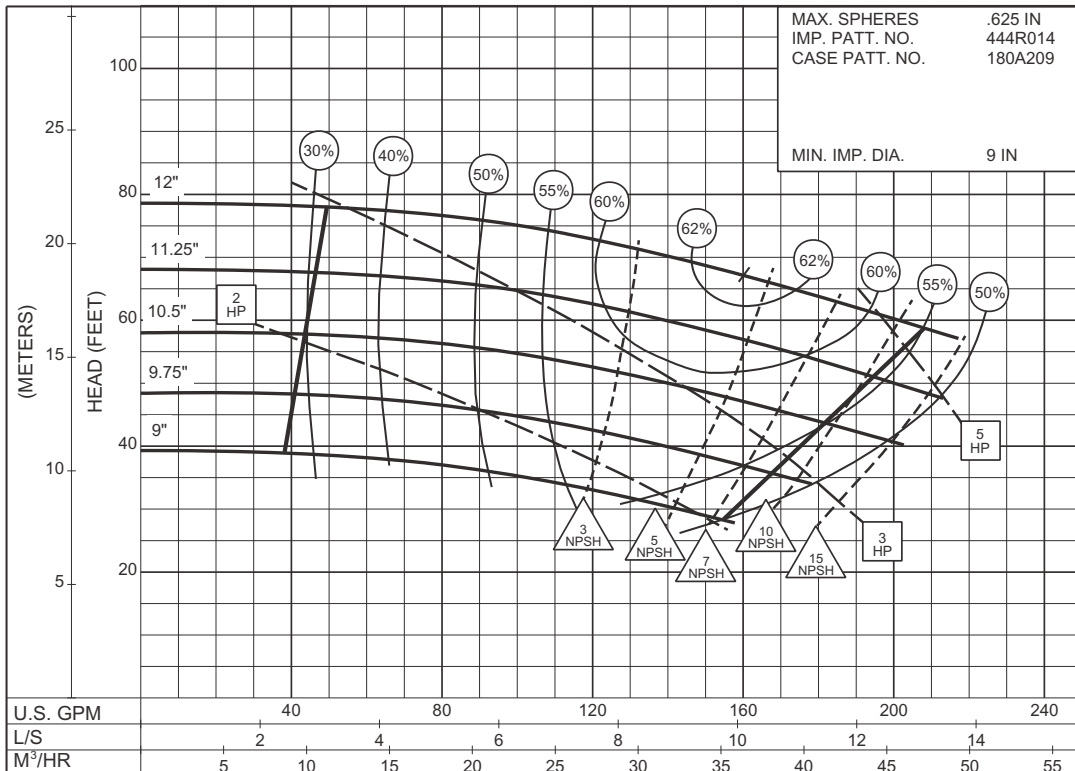

3PC-116289

**1150
R.P.M**

SIZE : 4x4x7A TYPE : 382 IMPELLER : Enclosed R. P. M. : 3500

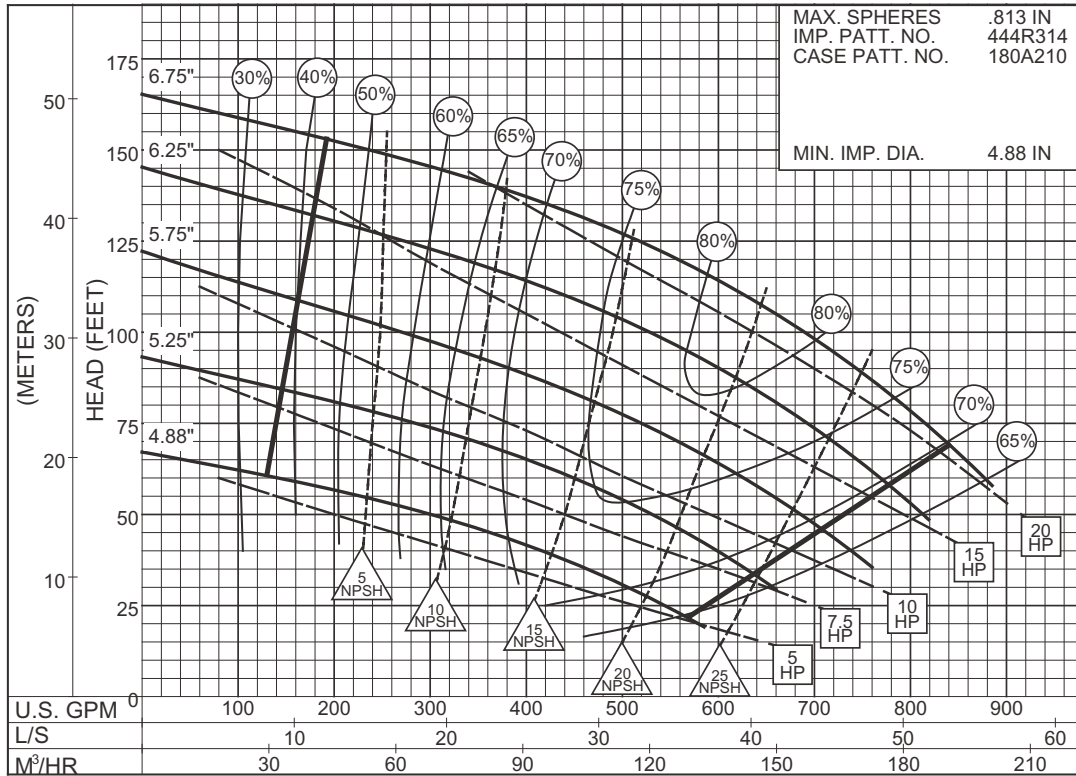

**3500
R.P.M**

SIZE : 4x4x7A TYPE : 382 IMPELLER : Enclosed R. P. M. : 1750

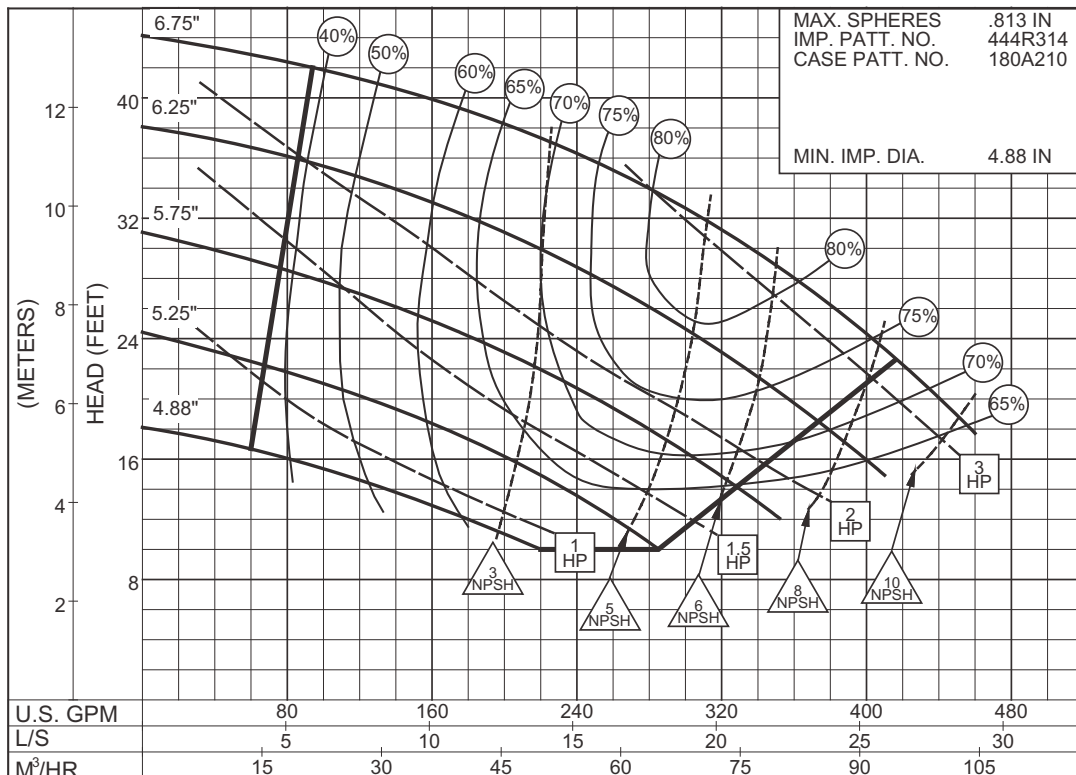

**1750
R.P.M**

SIZE : 4x4x7B TYPE : 382 IMPELLER : Enclosed R. P. M. : 3500

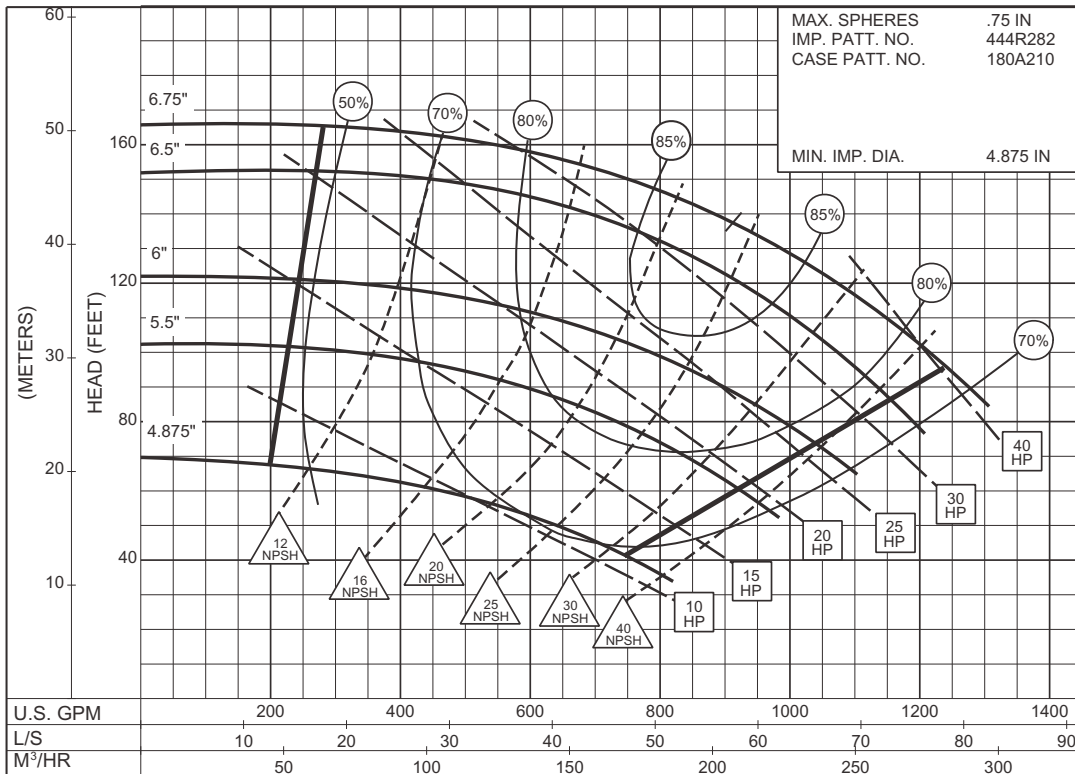

3PC-116307A

3500
R.P.M

SIZE : 4x4x7B TYPE : 382 IMPELLER : Enclosed R. P. M. : 1750

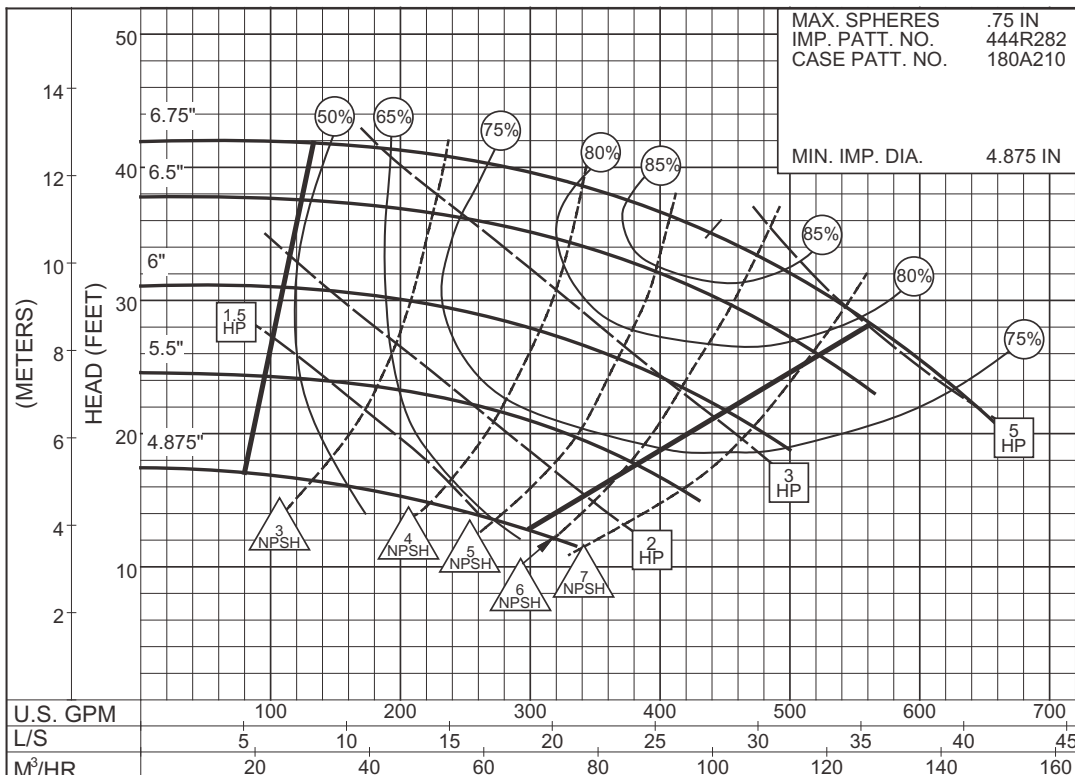

3PC-116308A

1750
R.P.M

SIZE : 4x4x9A TYPE : 382 IMPELLER : Enclosed R. P. M. : 3500

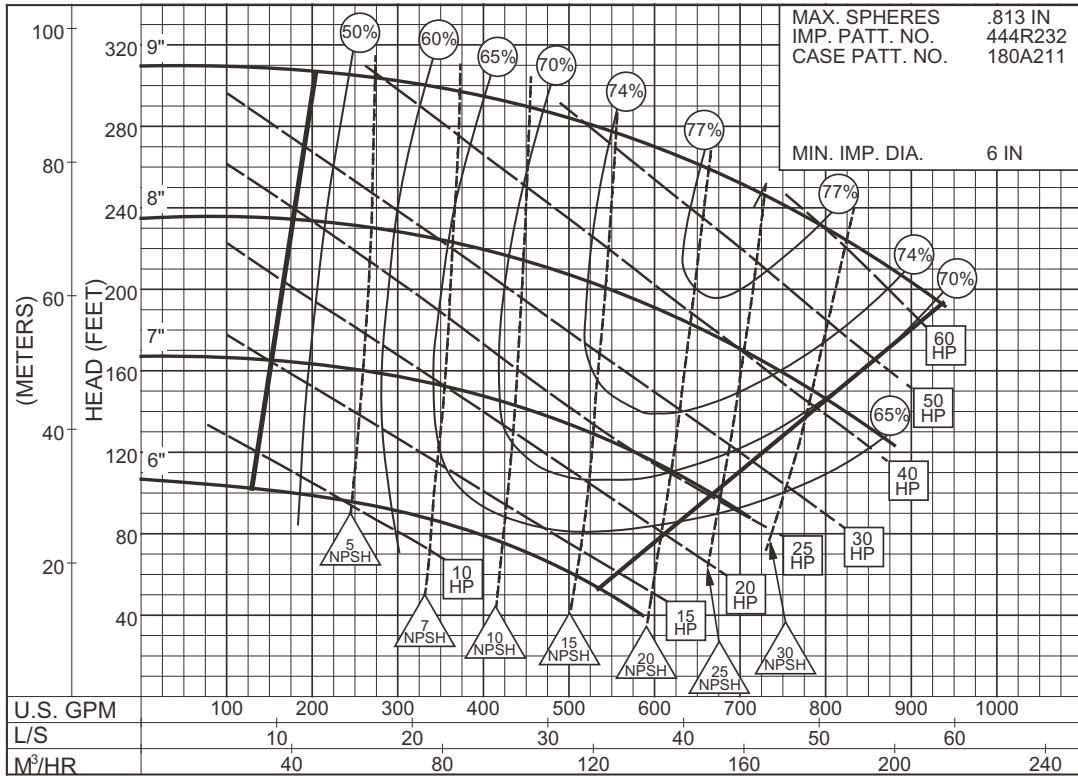

3PC-142439

3500 R.P.M

SIZE : 4x4x9A TYPE : 382 IMPELLER : Enclosed R. P. M. : 1750

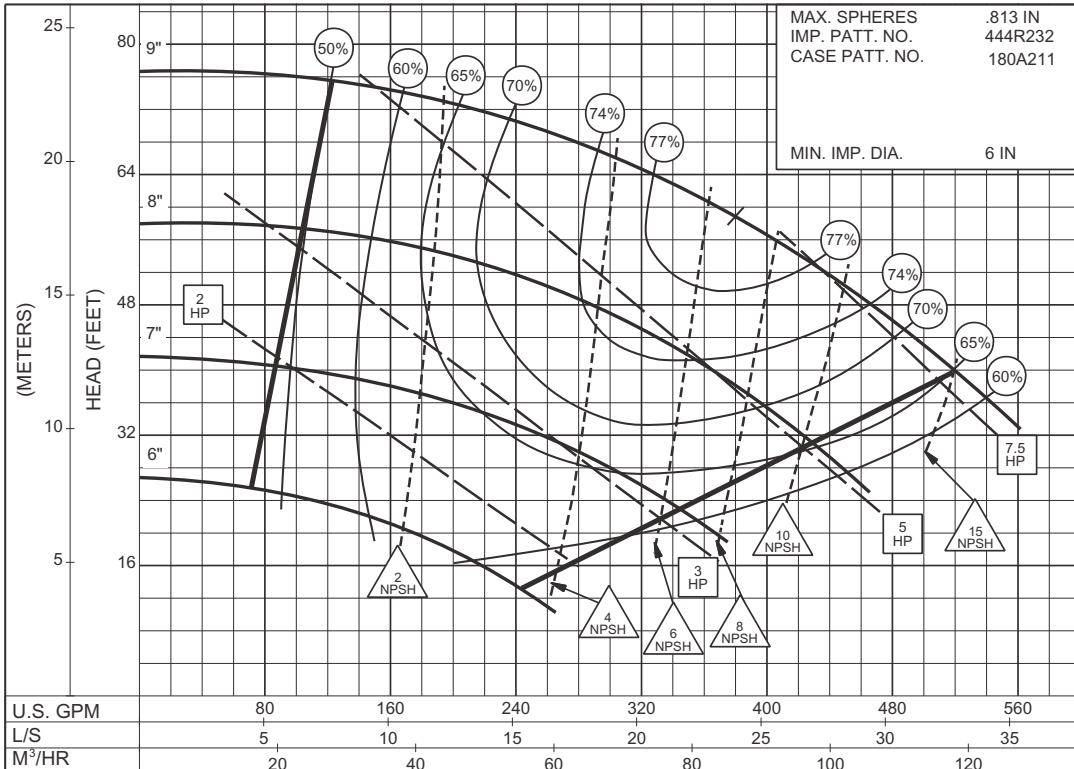

PC-142438

1750 R.P.M

SIZE : 4x4x9B TYPE : 382 IMPELLER : Enclosed R. P. M. : 3500

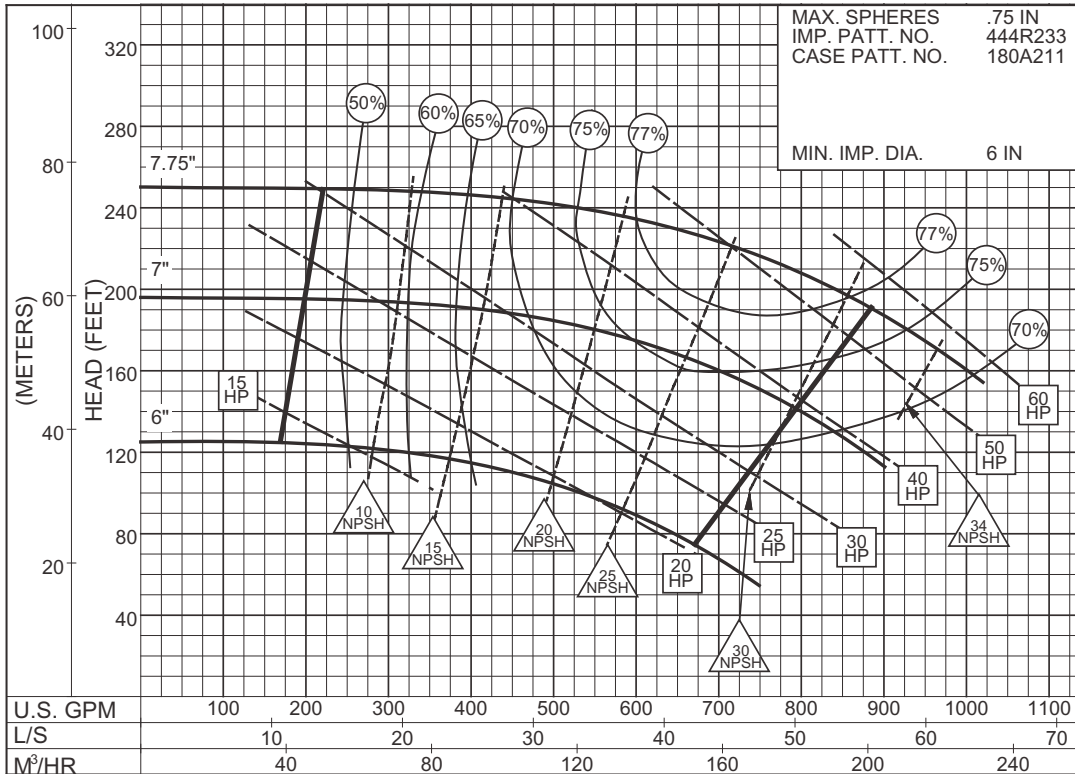

3PC-142441A

3500
R.P.M

SIZE : 4x4x9B TYPE : 382 IMPELLER : Enclosed R. P. M. : 1750

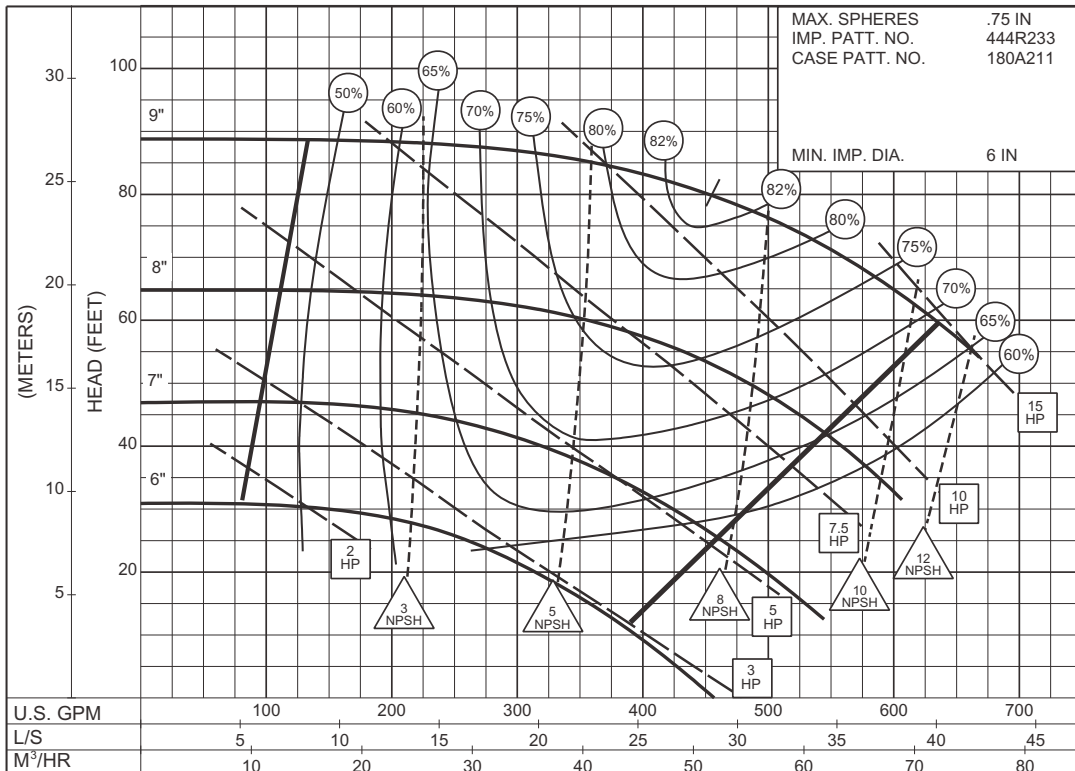

3PC-142440

1750
R.P.M

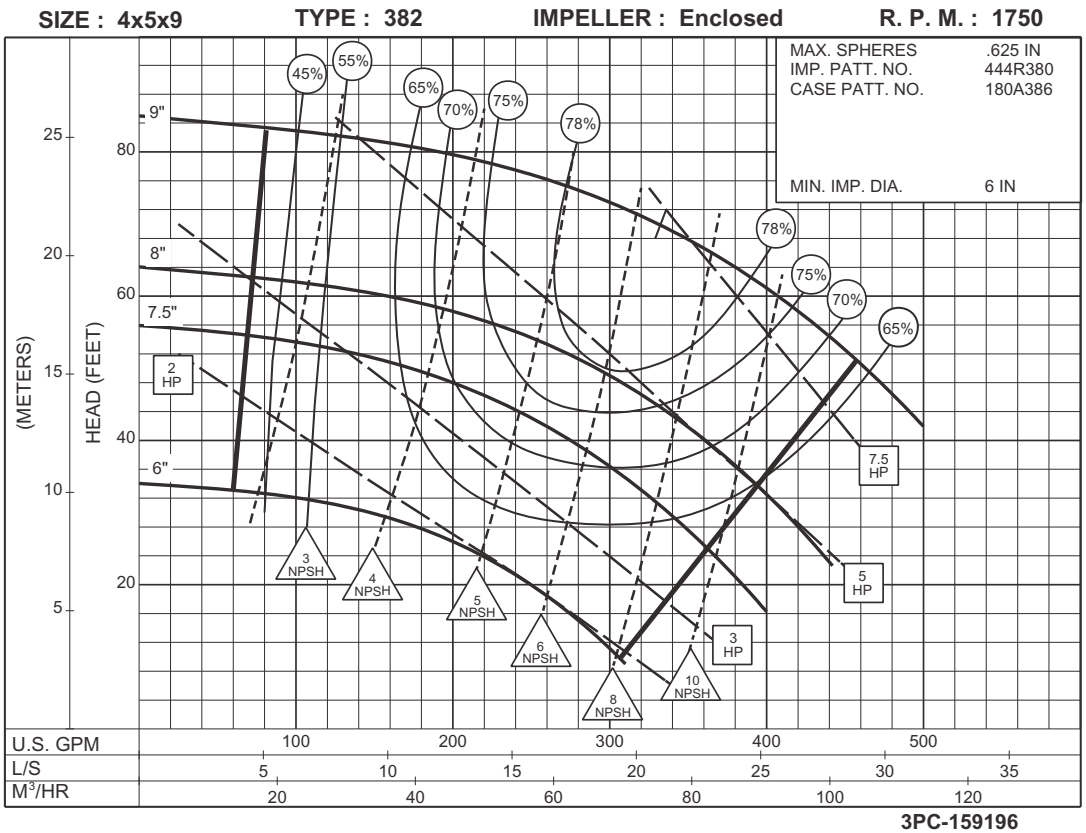
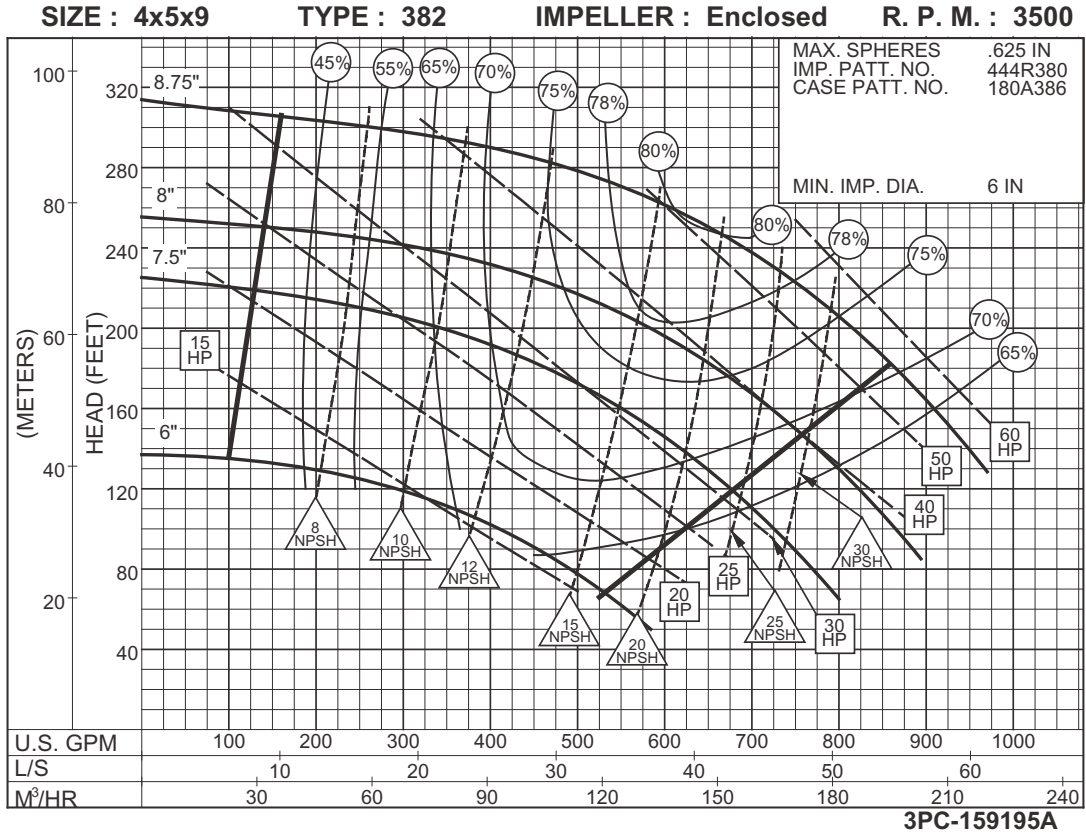

SIZE : 4x4x11 TYPE : 382 IMPELLER : Enclosed R. P. M. : 1760

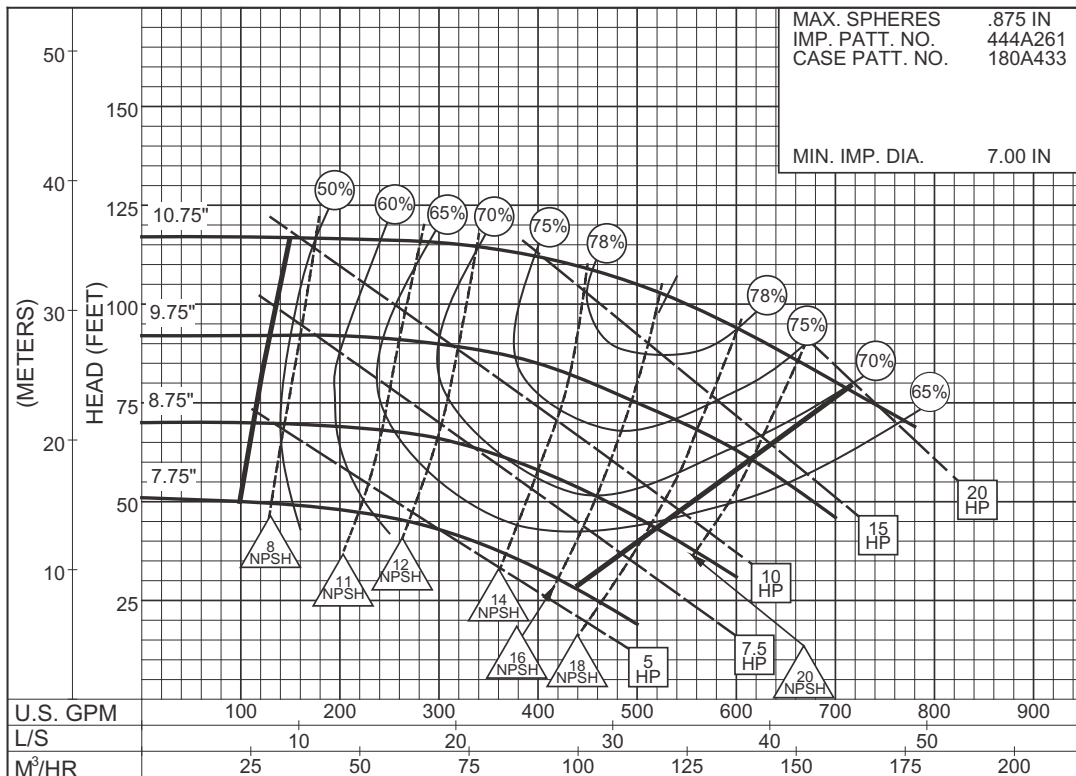

1760
R.P.M

PC-177189

SIZE : 4x4x11 TYPE : 382 IMPELLER : Enclosed R. P. M. : 1150

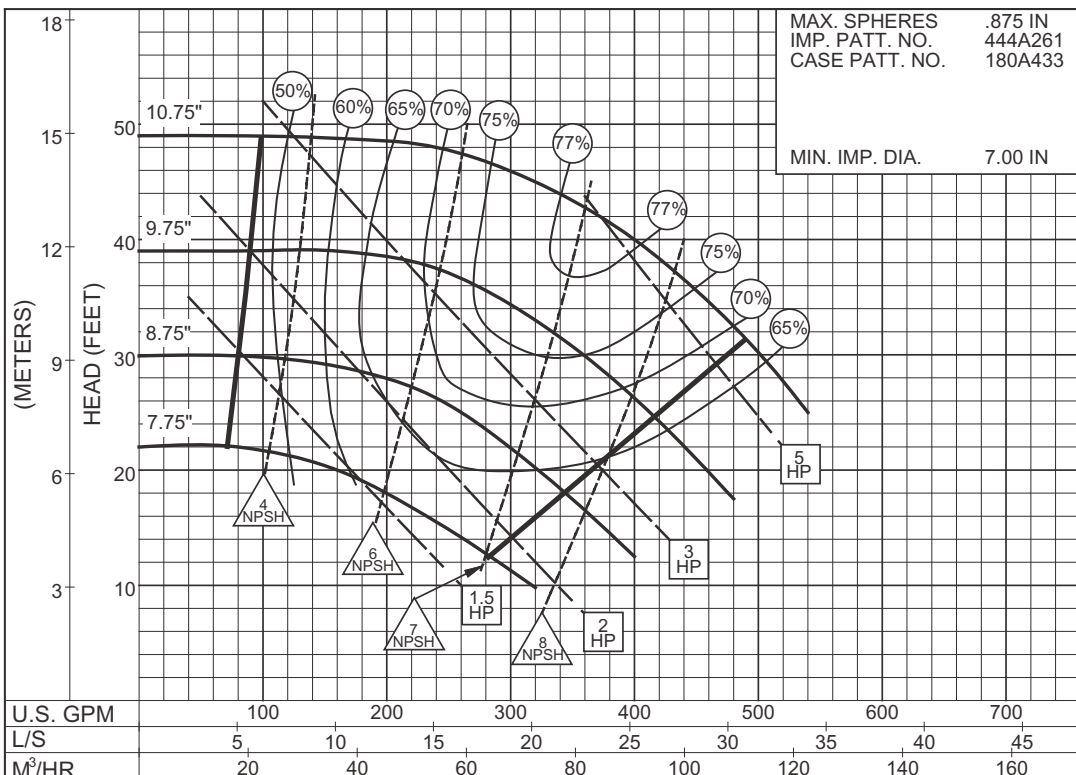

1150
R.P.M

PC-177190

SIZE : 4x4x12 TYPE : 382 IMPELLER : Enclosed R. P. M. : 1760

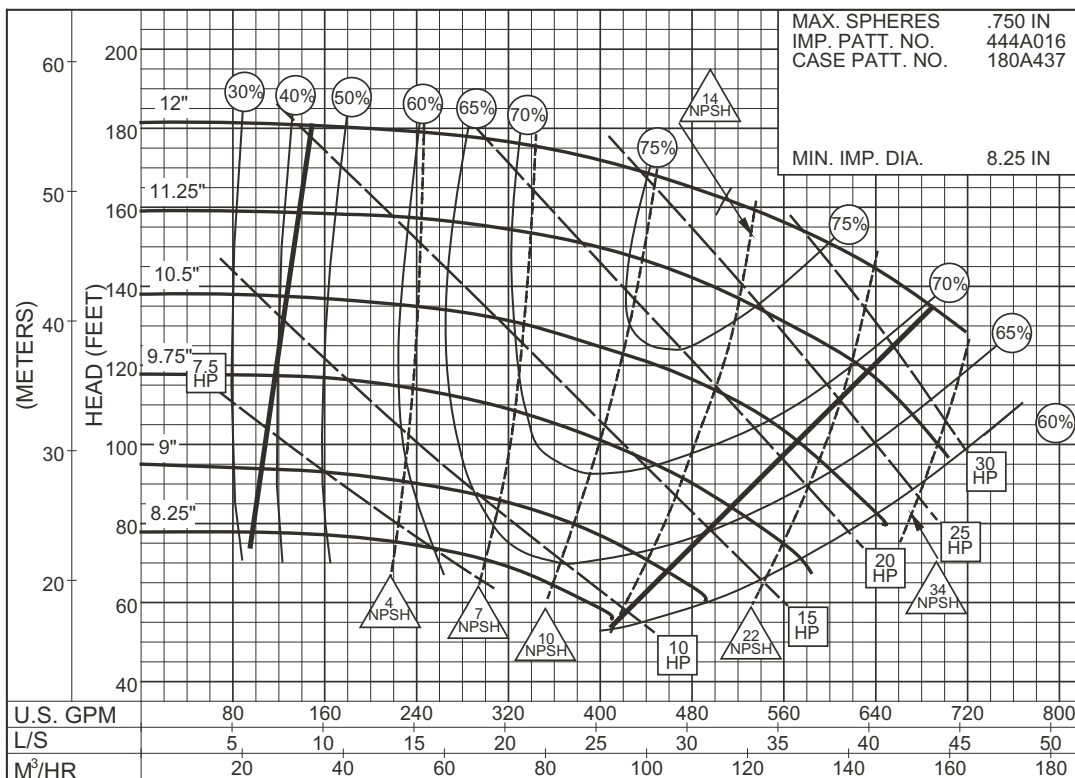

1760 R.P.M

PC-177201

SIZE : 4x4x12 TYPE : 382 IMPELLER : Enclosed R. P. M. : 1150

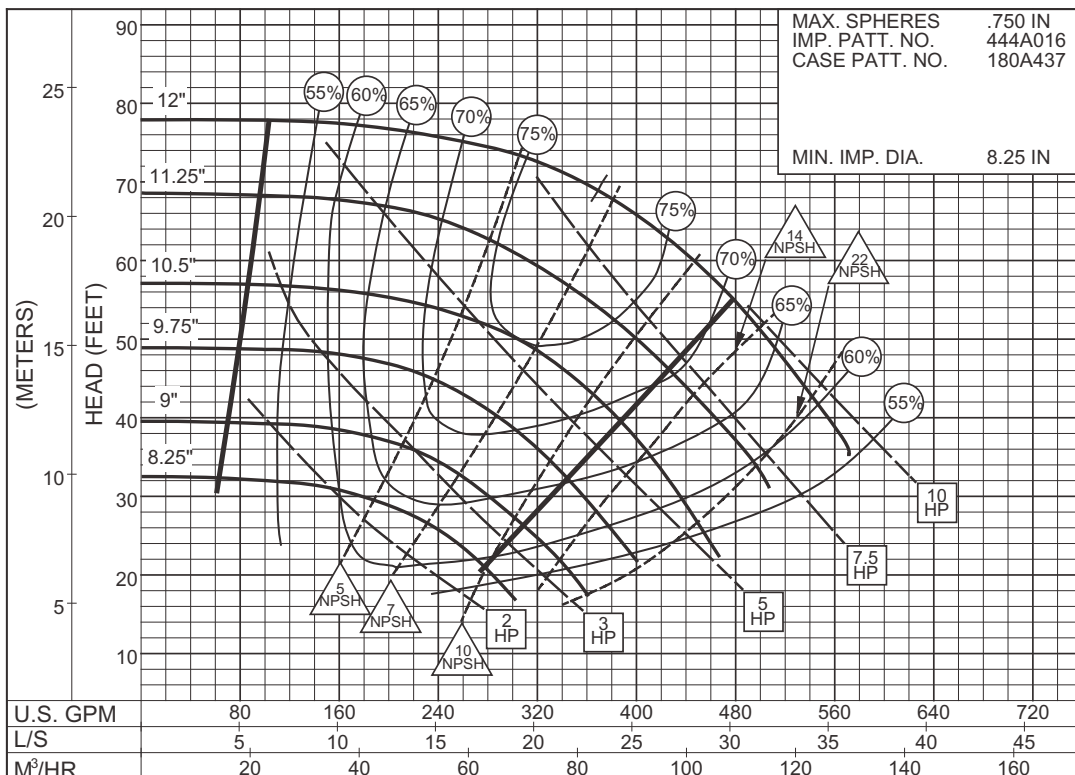

1150 R.P.M

PC-177202

SIZE : 5x5x9 TYPE : 382 IMPELLER : Enclosed R. P. M. : 1750

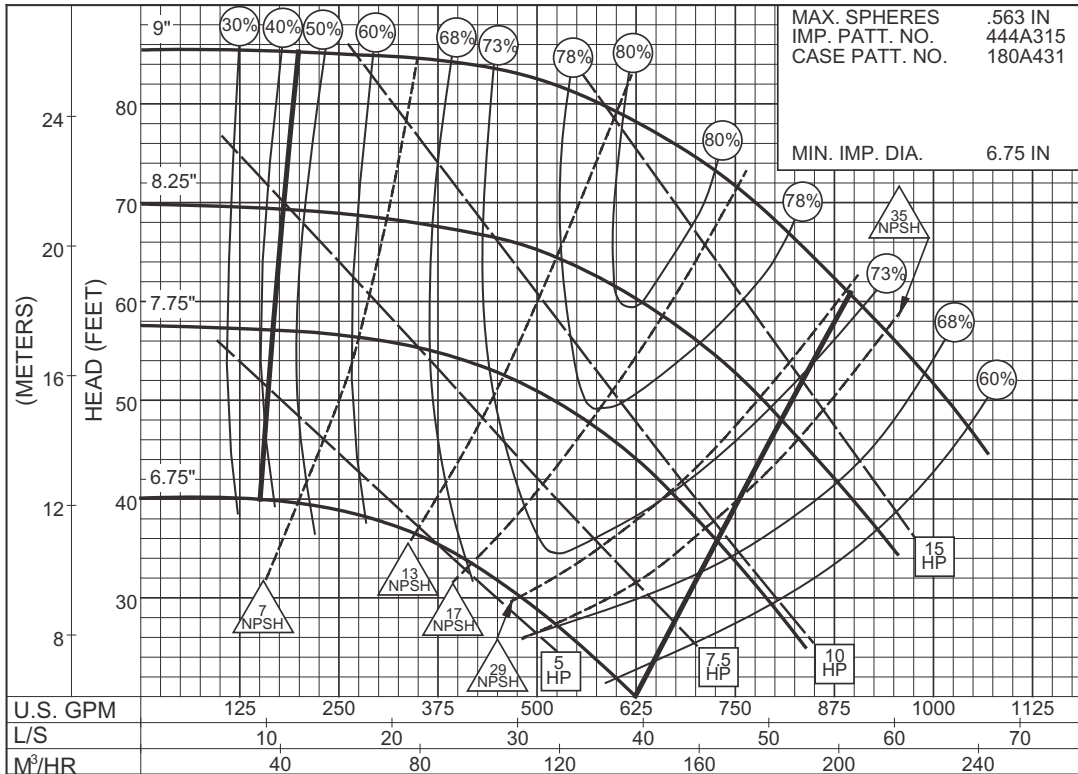

PC-177183

**1750
R.P.M**

SIZE : 5x5x9 TYPE : 382 IMPELLER : Enclosed R. P. M. : 1150

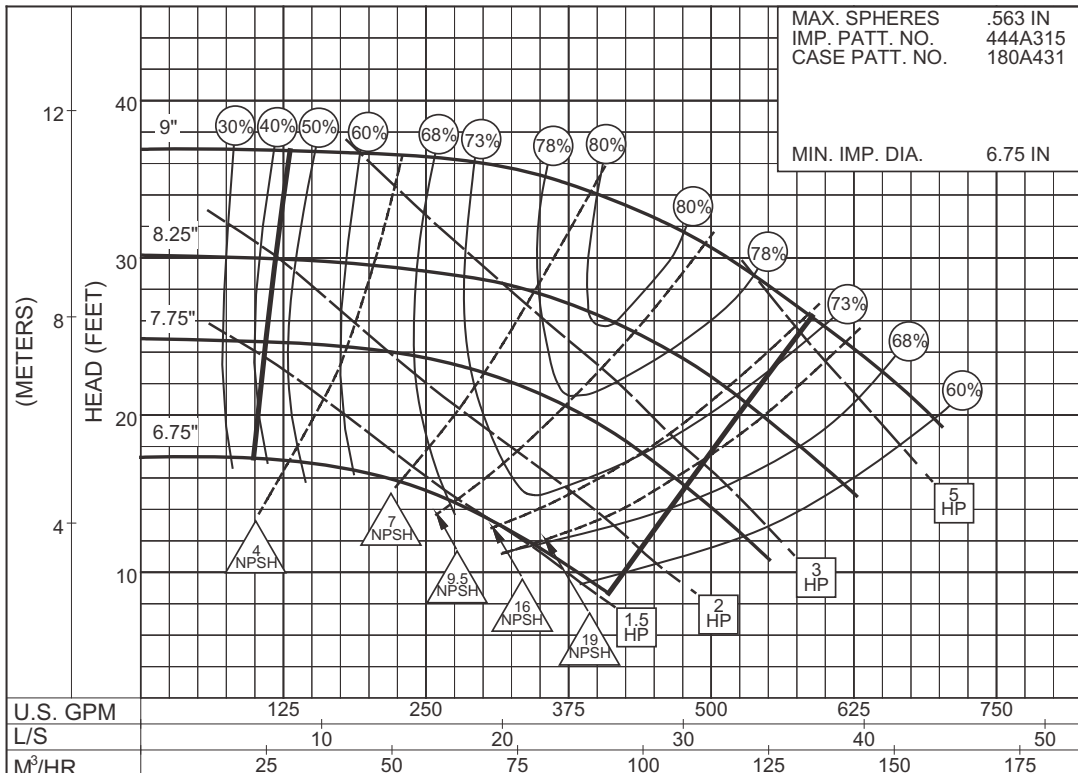

PC-177184

**1150
R.P.M**

SIZE : 5x5x11 TYPE : 382 IMPELLER : Enclosed R. P. M. : 1760

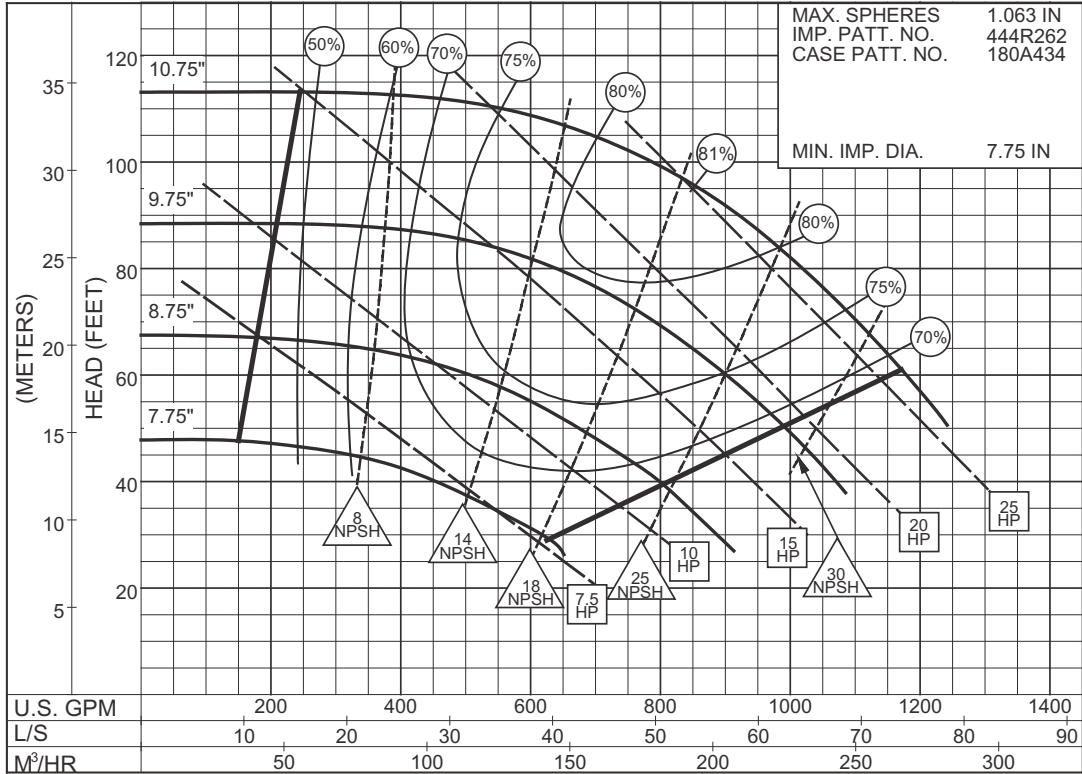

3PC-177192



SIZE : 5x5x11 TYPE : 382 IMPELLER : Enclosed R. P. M. : 1150

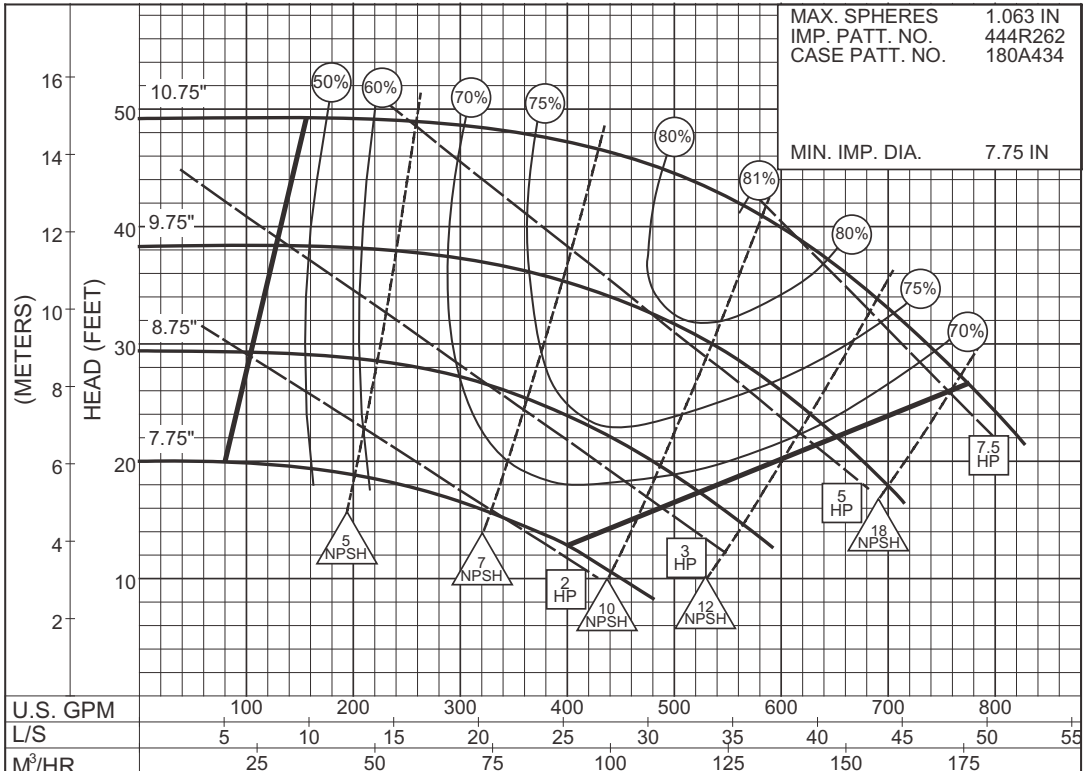

3PC-177193



SIZE : 5x5x12 TYPE : 382 IMPELLER : Enclosed R. P. M. : 1760

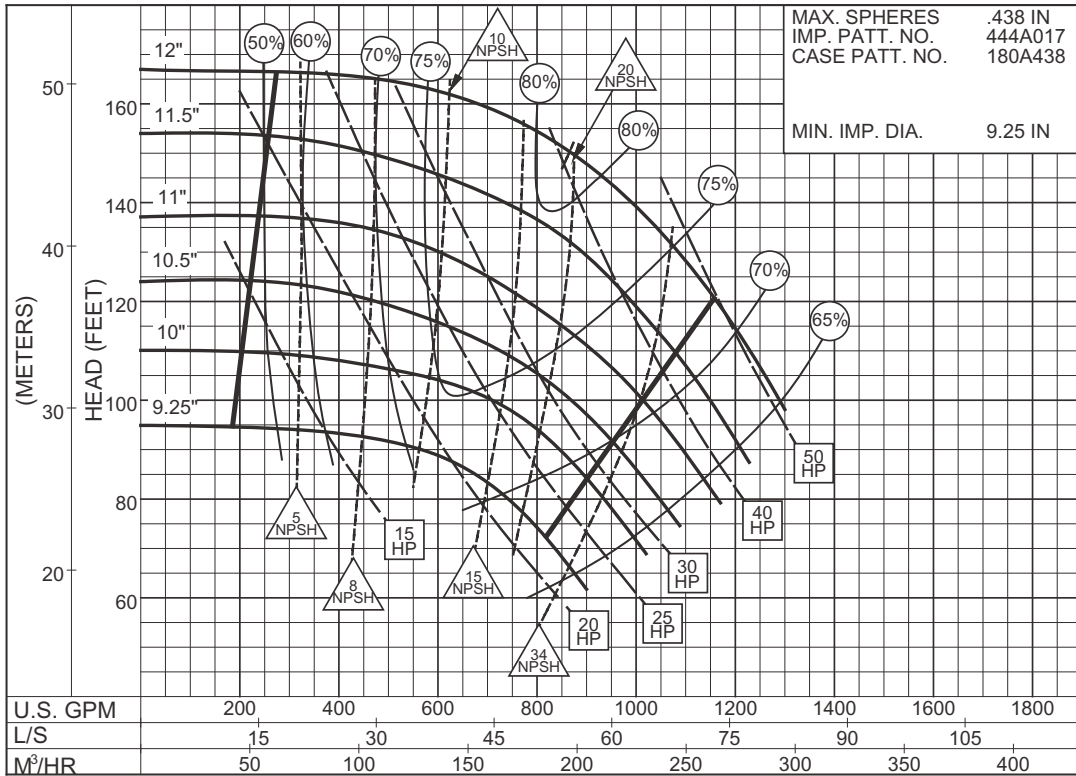

PC-177204

1760
R.P.M

SIZE : 5x5x12 TYPE : 382 IMPELLER : Enclosed R. P. M. : 1150

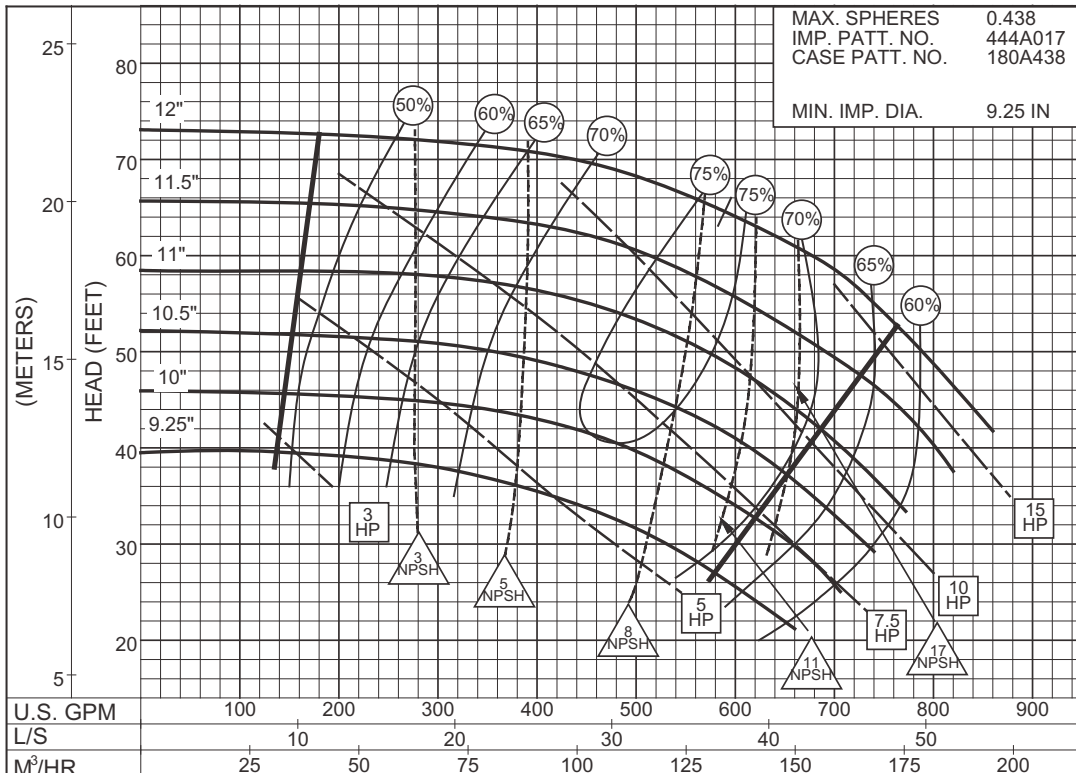

PC-177205

1150
R.P.M

SIZE : 6x6x9 TYPE : 382 IMPELLER : Enclosed R. P. M. : 1750

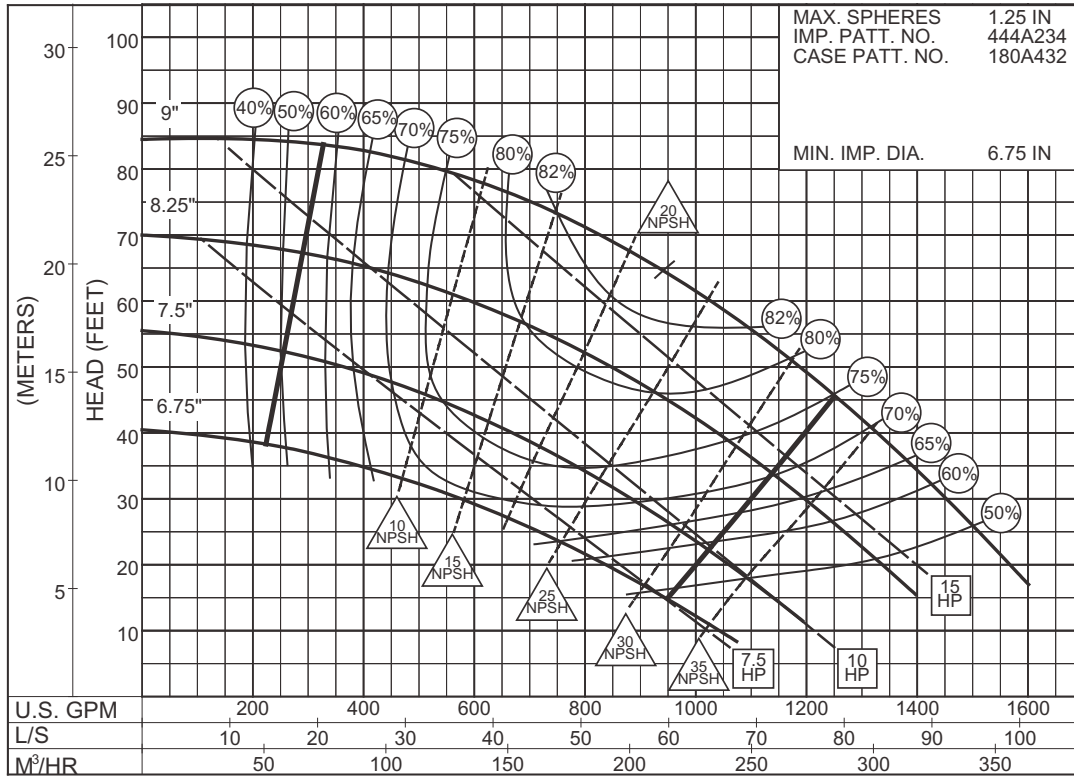

**1750
R.P.M**

SIZE : 6x6x9 TYPE : 382 IMPELLER : Enclosed R. P. M. : 1150

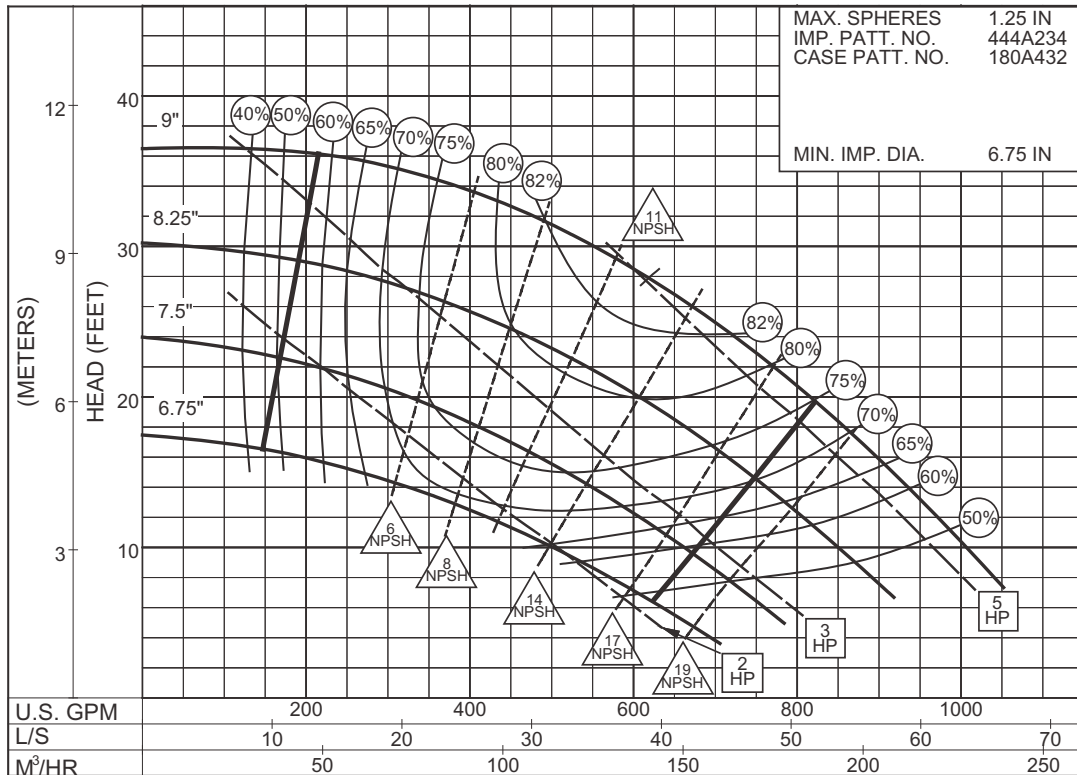

**1150
R.P.M**

SIZE : 6x6x11

TYPE : 382

IMPELLER : Enclosed R. P. M. : 1760

MAX. SPHERES 1.000 IN
 IMP. PATT. NO. 444A263
 CASE PATT. NO. 180A435
 MIN. IMP. DIA. 7.75 IN

1760
R.P.M

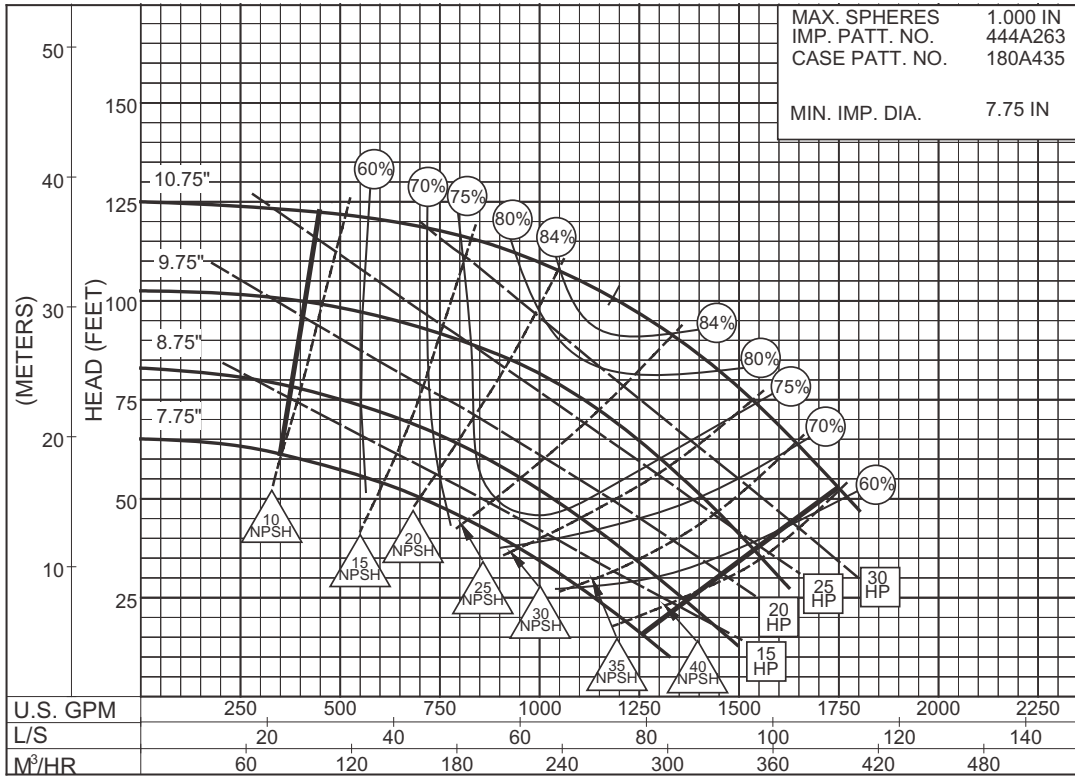

PC - 177195

SIZE : 6x6x11

TYPE : 382

IMPELLER : Enclosed R. P. M. : 1150

MAX. SPHERES 1.000 IN
 IMP. PATT. NO. 444A263
 CASE PATT. NO. 180A435
 MIN. IMP. DIA. 7.75 IN

1150
R.P.M

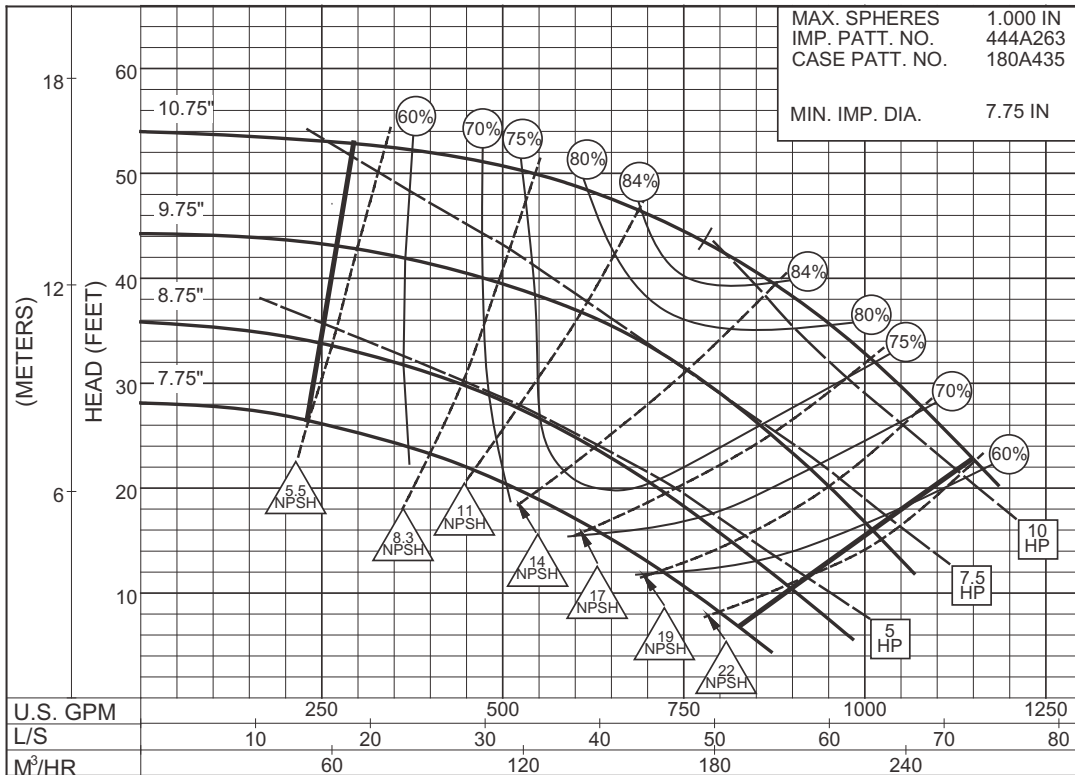

PC - 177196

SIZE : 6x6x12 TYPE : 382A IMPELLER : Enclosed R. P. M. : 1760

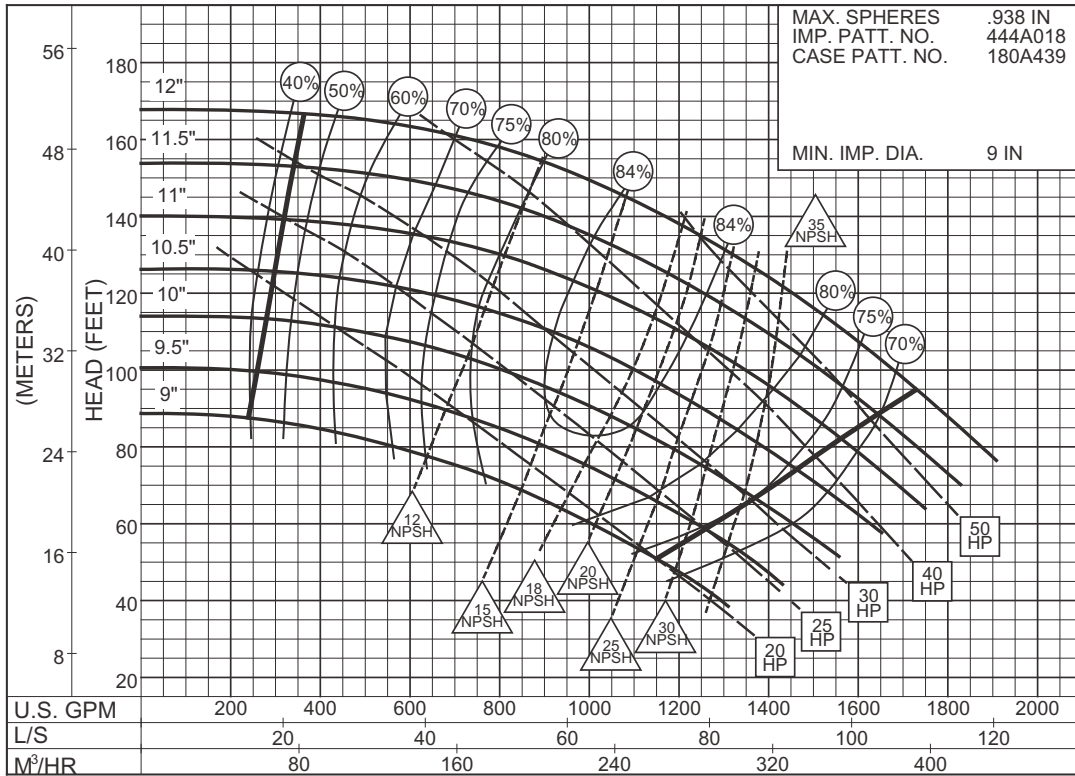

1760 R.P.M

PC- 177207

SIZE : 6x6x12 TYPE : 382A IMPELLER : Enclosed R. P. M. : 1150

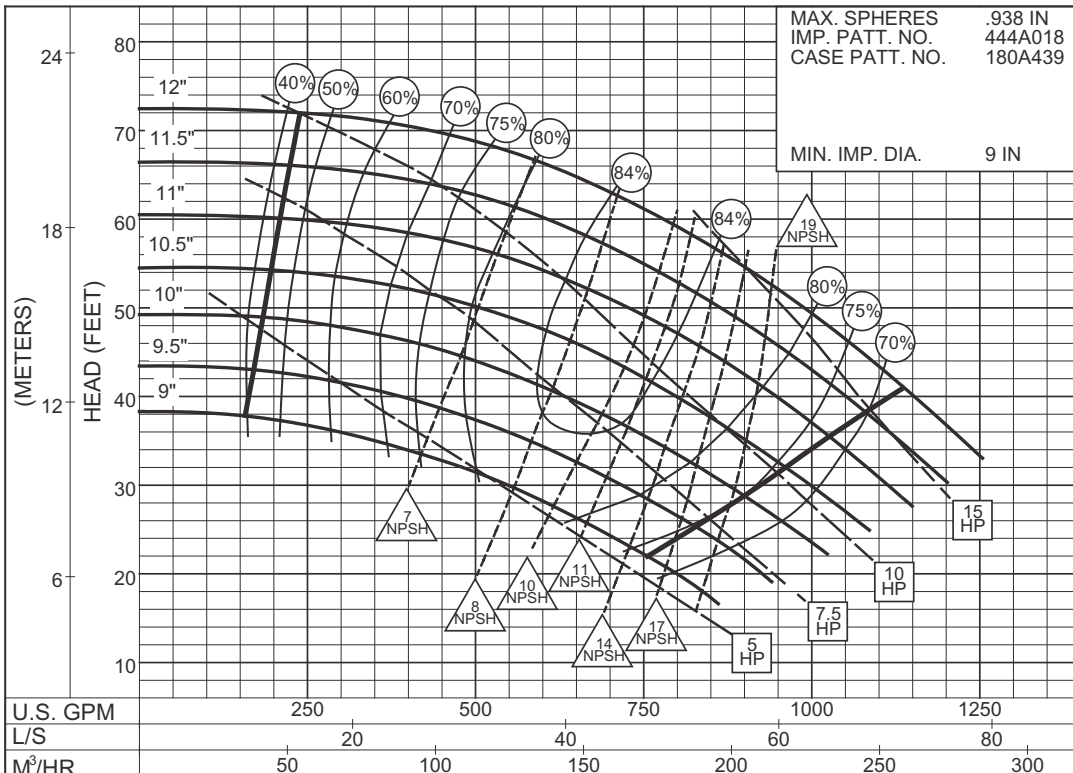

1150 R.P.M

PC- 177208

SIZE : 8x8x11 TYPE : 382 IMPELLER : Enclosed R. P. M. : 1760

MAX. SPHERES 1.000 IN
 IMP. PATT. NO. 444A263
 CASE PATT. NO. 180A436
 MIN. IMP. DIA. 7.75 IN

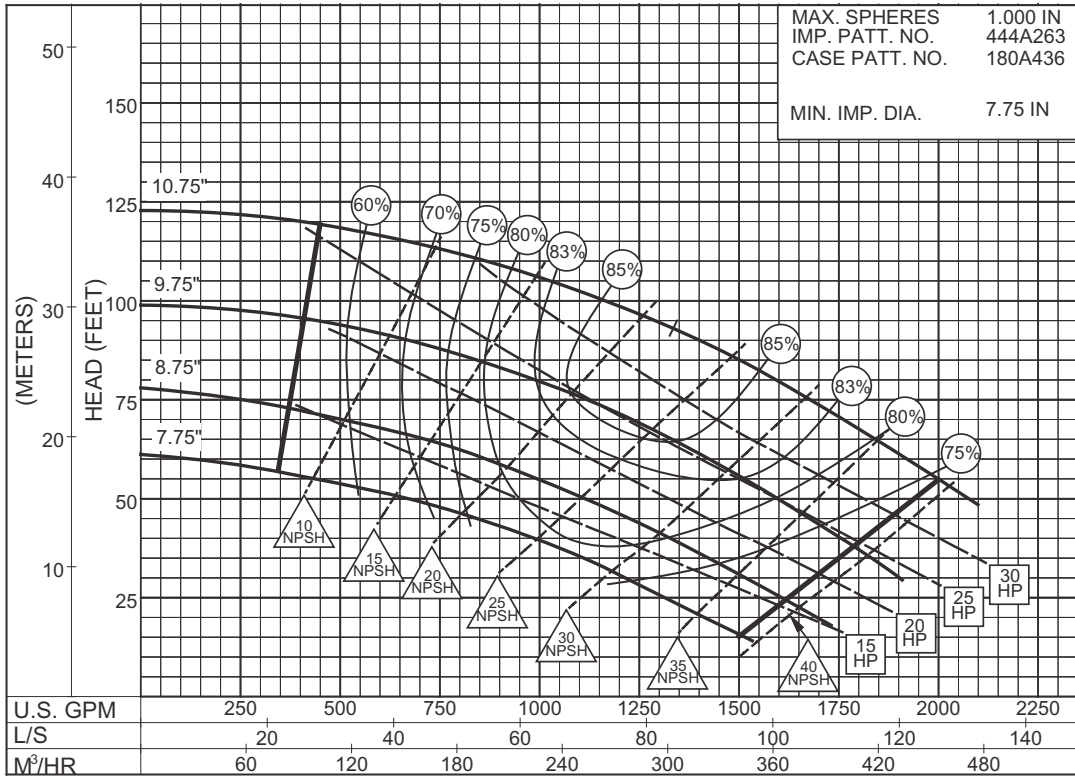

PC-177198

**1760
R.P.M**

SIZE : 8x8x11 TYPE : 382 IMPELLER : Enclosed R. P. M. : 1150

MAX. SPHERES 1.000 IN
 IMP. PATT. NO. 444A263
 CASE PATT. NO. 180A436
 MIN. IMP. DIA. 7.75 IN

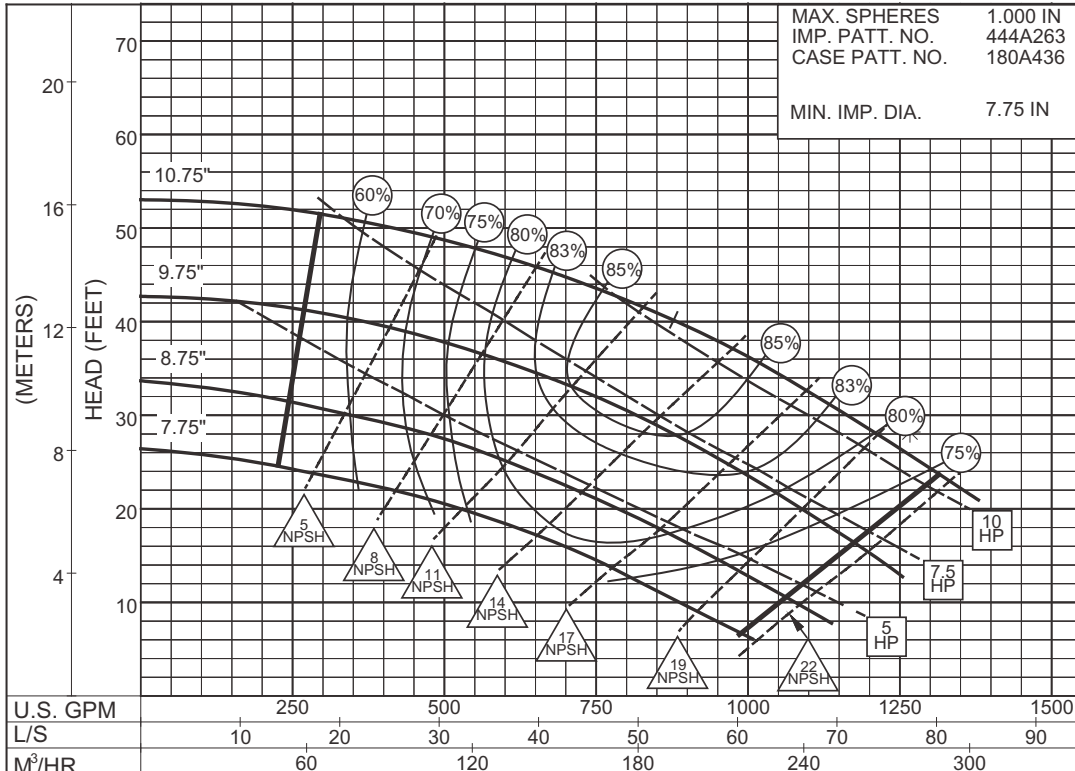

PC-177199

**1150
R.P.M**

SIZE : 8x8x12 TYPE : 382 IMPELLER : Enclosed R. P. M. : 1760

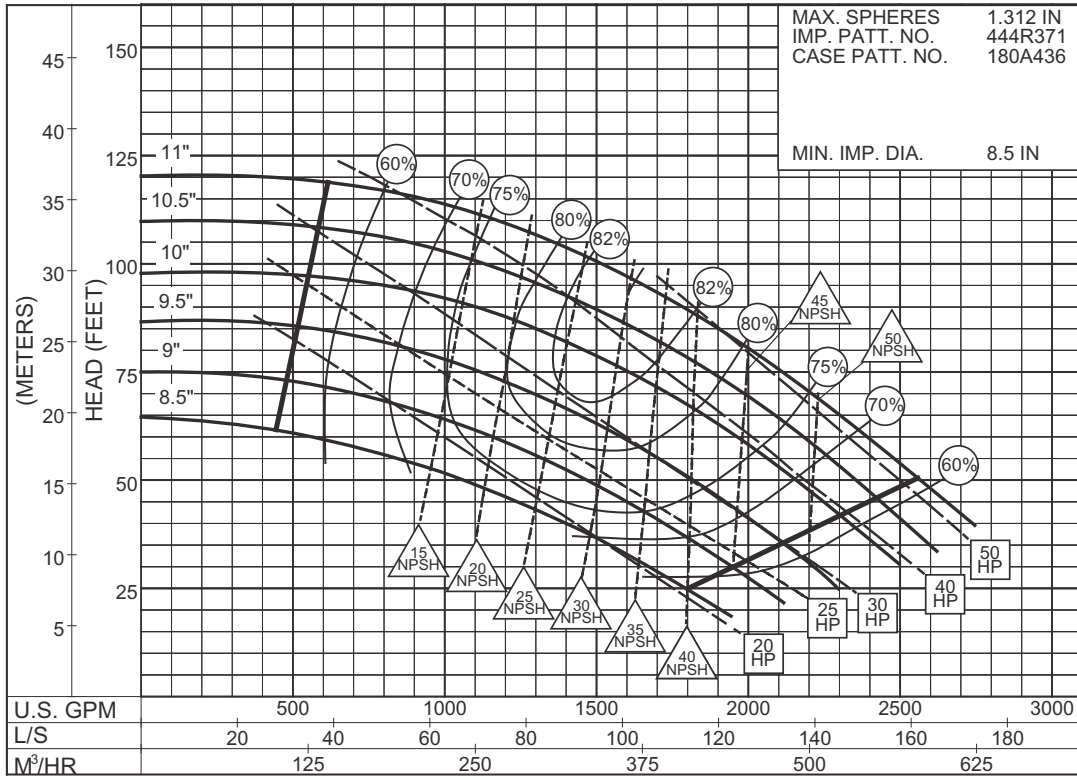

PC - 177210



SIZE : 8x8x12 TYPE : 382 IMPELLER : Enclosed R. P. M. : 1150

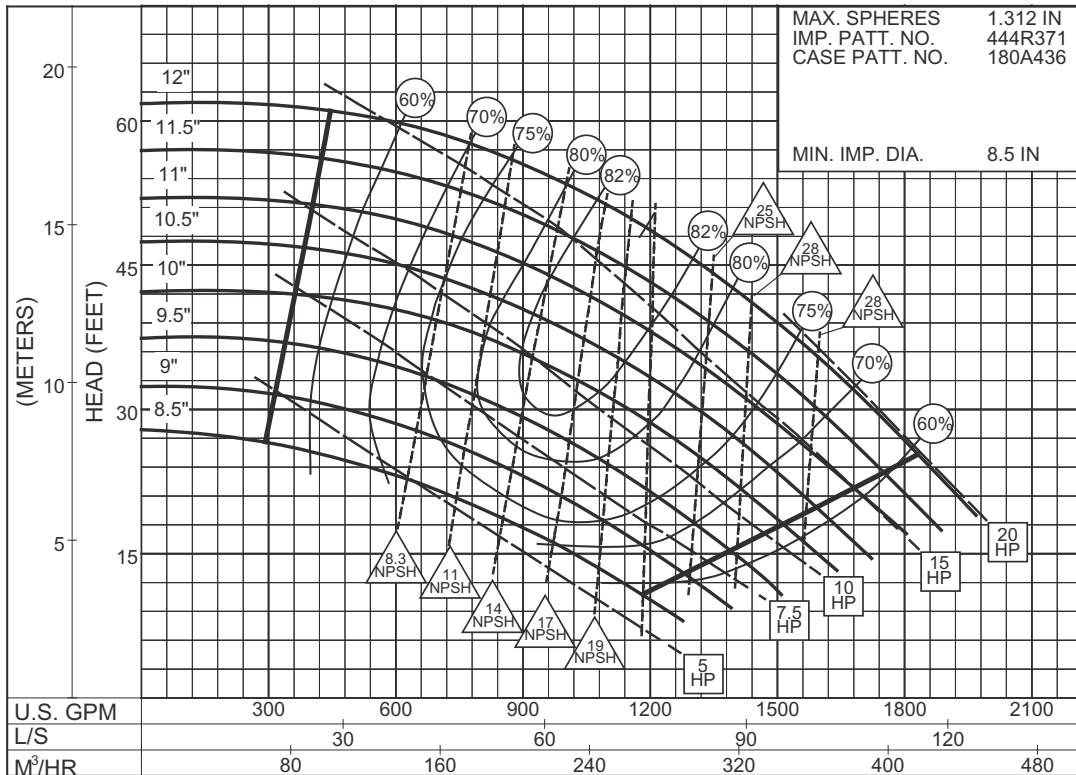

PC - 177211



SIZE : 8x8x15 TYPE : 382 IMPELLER : Enclosed R. P. M. : 1775

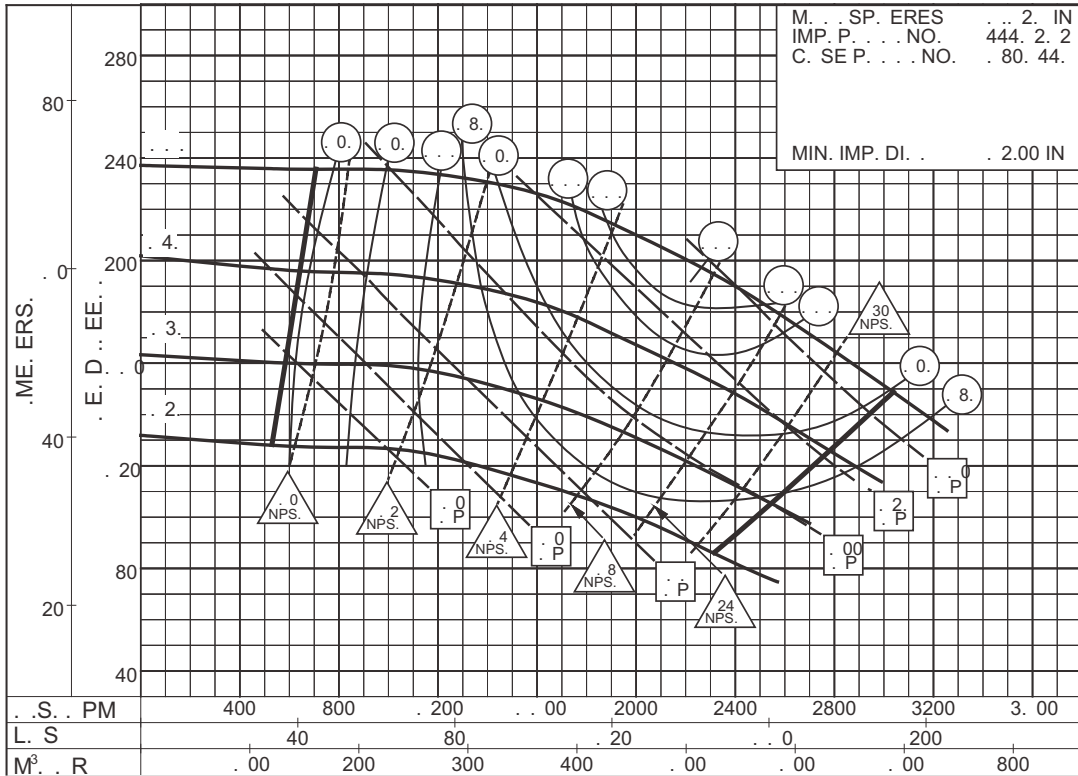

1775
R.P.M

SIZE : 8x8x15 TYPE : 382 IMPELLER : Enclosed R. P. M. : 1150

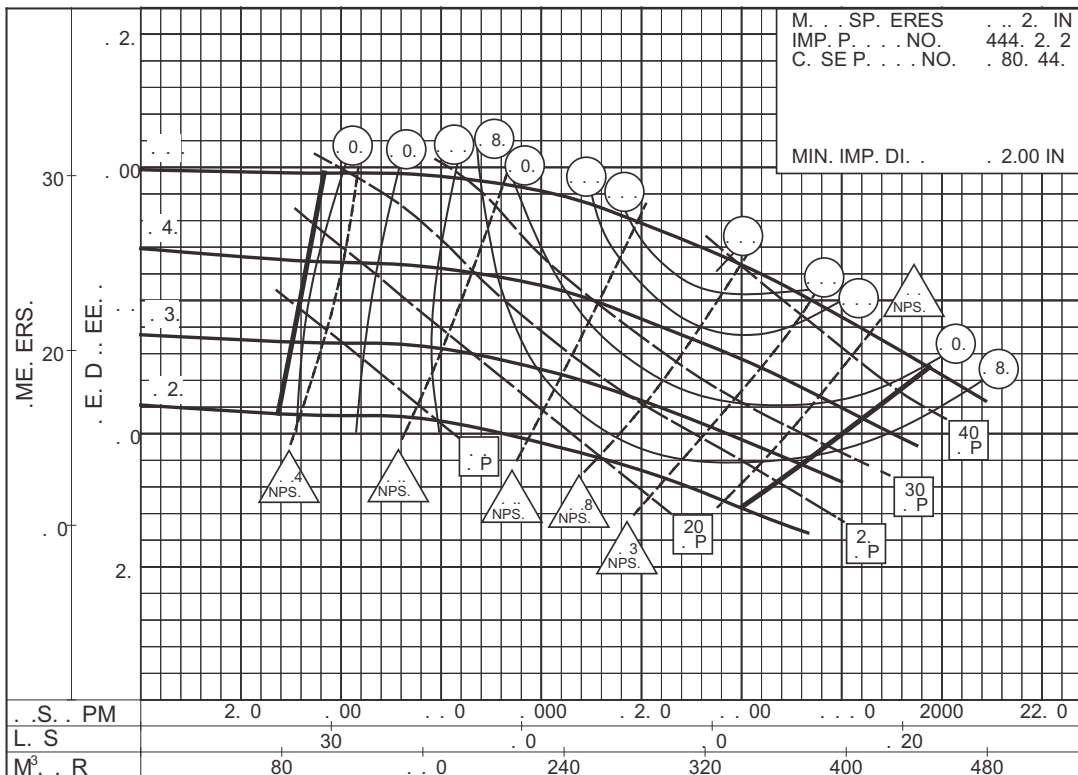

1150
R.P.M

SIZE : 10x10x15

TYPE : 382A IMPELLER : Enclosed R. P. M. : 1775

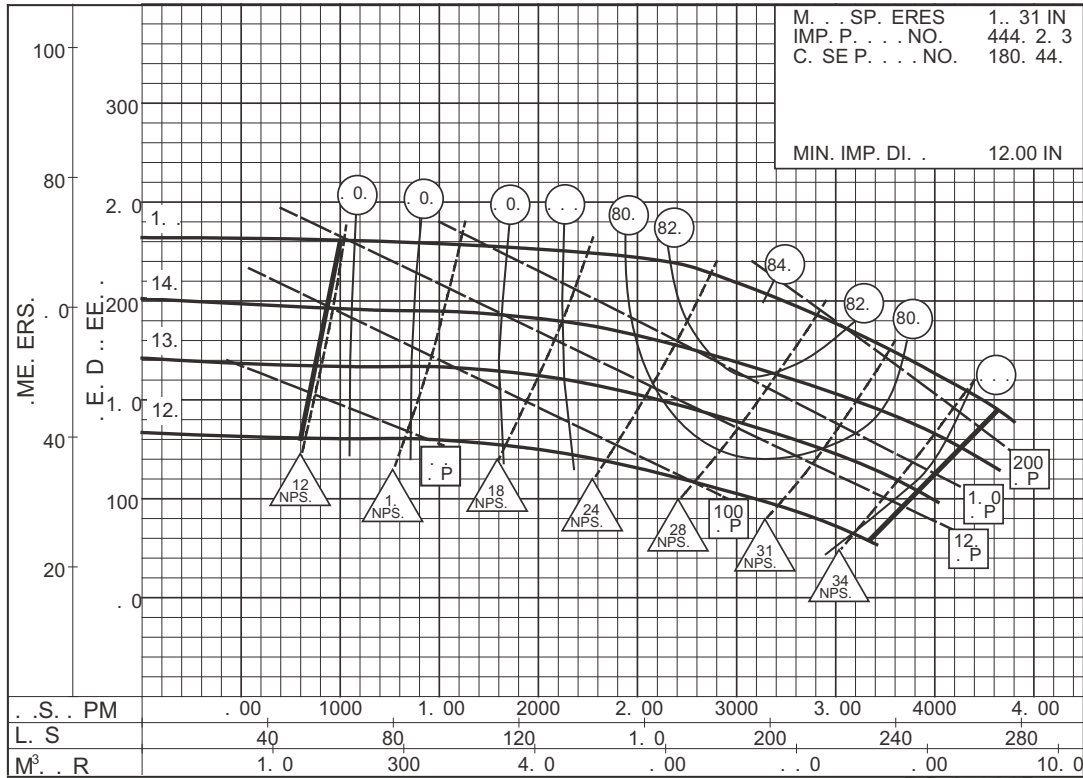

1775 R.P.M

SIZE : 10x10x15

TYPE : 382A IMPELLER : Enclosed R. P. M. : 1150

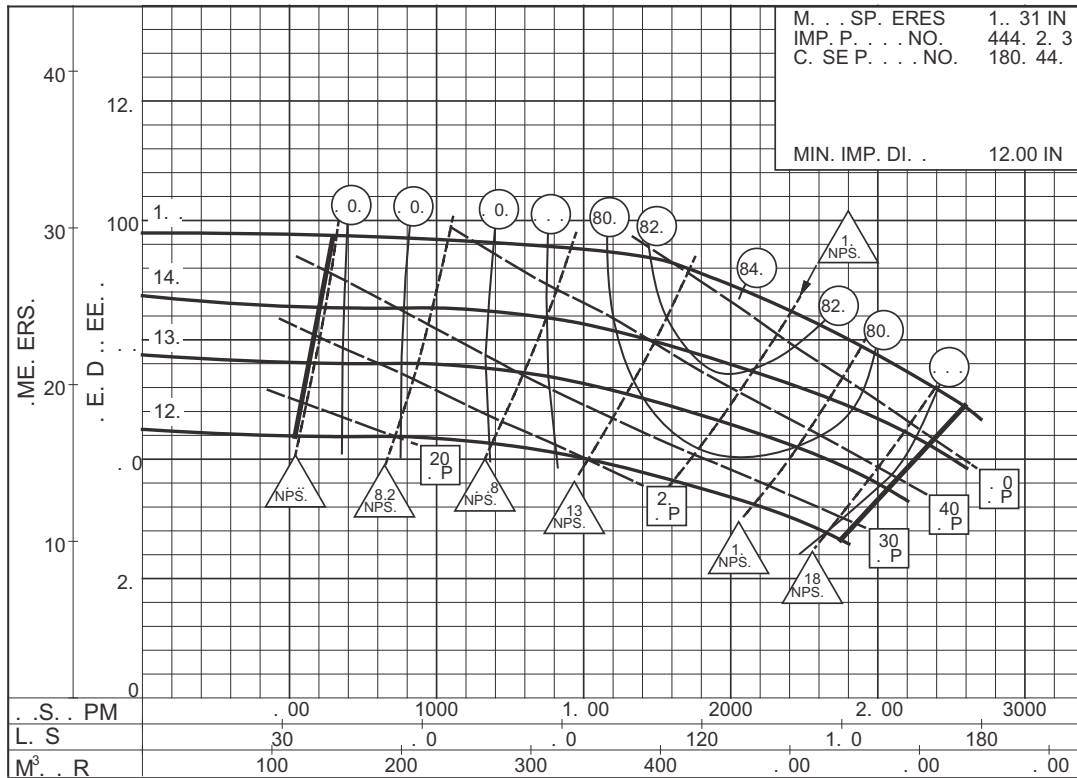

1150 R.P.M